

Security Command[®]
EXECUTIVE SERIES

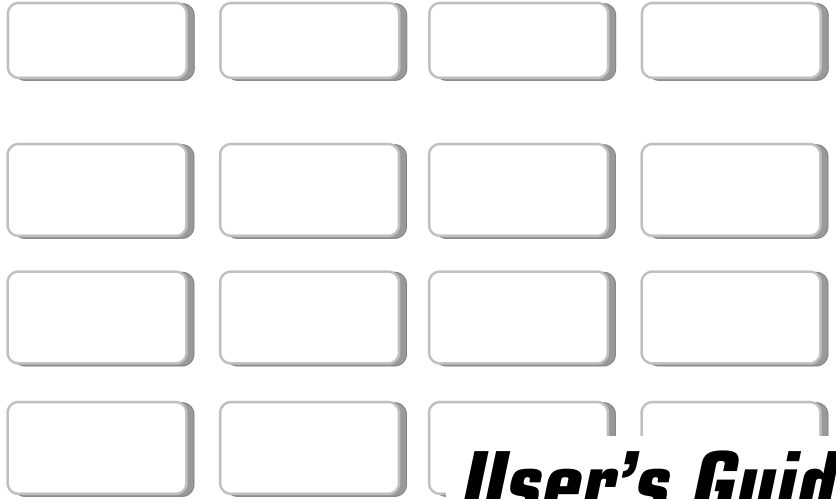

User's Guide

Security Command[®]
EXECUTIVE SERIES

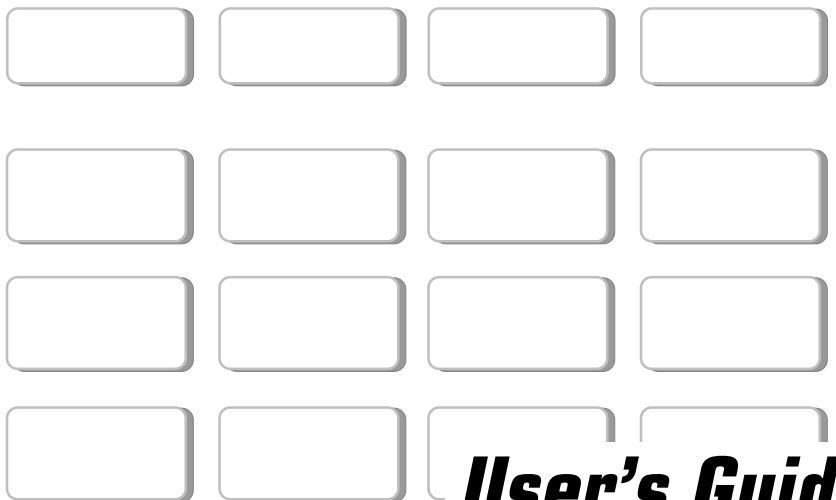

User's Guide

Silencing an Alarm

All/Perimeter and Home/Away Systems

1. While the alarm bell or siren is sounding, enter your user code. The keypad displays **DISARM SILENCE**.
2. Press the SELECT key under **SILENCE** to stop the bell or siren. This does NOT disarm the system.
3. If your system is programmed to send an Abort (alarm cancel) report to the central station, the keypad displays **ALARM CANCELLED**.

Area Systems

1. While the alarm bell or siren is sounding, enter your user code. The system silences the alarm bell or siren.
2. If your system is programmed to send an Abort (alarm cancel) report to the central station, the keypad displays **ALARM CANCELLED**.

Copyright© 1995 - 1997 Digital Monitoring Products, Inc.
Information furnished by DMP is believed to be accurate and reliable.
This information is subject to change without notice.

Silencing an Alarm

All/Perimeter and Home/Away Systems

1. While the alarm bell or siren is sounding, enter your user code. The keypad displays **DISARM SILENCE**.
2. Press the SELECT key under **SILENCE** to stop the bell or siren. This does NOT disarm the system.
3. If your system is programmed to send an Abort (alarm cancel) report to the central station, the keypad displays **ALARM CANCELLED**.

Area Systems

1. While the alarm bell or siren is sounding, enter your user code. The system silences the alarm bell or siren.
2. If your system is programmed to send an Abort (alarm cancel) report to the central station, the keypad displays **ALARM CANCELLED**.

Copyright© 1995 - 1997 Digital Monitoring Products, Inc.
Information furnished by DMP is believed to be accurate and reliable.
This information is subject to change without notice.

Security Command User's Guide

for XR200 Command Processor Panels

Table of Contents

About your system

Emergency Evacuation Plans	ii
About Your Security System	1
The Security Command Keypad	2
Special Security Command Displays	3
Special Security Command Tones	4
Understanding Security System Terms	4
General Arming Operation	6

Arming and Disarming

Area System Arming	7
Area System Disarming	8
All/Perimeter System Arming	9
All/Perimeter System Disarming	10
Home/Away System Arming	11
Home/Away System Disarming	12

User Menu

Security Command User Menu	13
Alarm Silence	14
Sensor Reset	14
Door Access	15
Armed Areas Display	15
Outputs On Off	16

Zone Status	16
Bypass Zones	17
Zone Monitor	18
System Status	19
System Test	19
User Codes	20
Schedules	23
Setting the Date and Time	27

Display Events

Display Events	28
Arming and Disarming Event Displays	29
Zone Event Displays	29
User Code Change Event Displays	30
System Monitor Event Displays	30
Door Access Event Displays	31
Schedule Change Event Displays	31
Zone Bypass Event Displays	32
Service Request Feature	32

How Your System is Setup

System Setup	33
Appendix	38

Security Command User's Guide

for XR200 Command Processor Panels

Table of Contents

About your system

Emergency Evacuation Plans	ii
About Your Security System	1
The Security Command Keypad	2
Special Security Command Displays	3
Special Security Command Tones	4
Understanding Security System Terms	4
General Arming Operation	6

Arming and Disarming

Area System Arming	7
Area System Disarming	8
All/Perimeter System Arming	9
All/Perimeter System Disarming	10
Home/Away System Arming	11
Home/Away System Disarming	12

User Menu

Security Command User Menu	13
Alarm Silence	14
Sensor Reset	14
Door Access	15
Armed Areas Display	15
Outputs On Off	16

Zone Status	16
Bypass Zones	17
Zone Monitor	18
System Status	19
System Test	19
User Codes	20
Schedules	23
Setting the Date and Time	27

Display Events

Display Events	28
Arming and Disarming Event Displays	29
Zone Event Displays	29
User Code Change Event Displays	30
System Monitor Event Displays	30
Door Access Event Displays	31
Schedule Change Event Displays	31
Zone Bypass Event Displays	32
Service Request Feature	32

How Your System is Setup

System Setup	33
Appendix	38

Emergency Evacuation Plans

The National Fire Protection Association recommends that you establish an emergency evacuation plan to safeguard lives in the event of a fire or other emergency. Use the following steps as a guide.

Draw a floorplan of your home or business

On a clean sheet of paper, draw the walls, windows, doors, and stairs. Also draw any obstacles that a person may encounter while exiting the building such as large furniture or appliances.

Develop escape routes

Determine at least two routes the occupants in each room can take to safely escape. One route can be the most obvious such as the door. Another can be through a window that can be easily opened. If the window is high off the ground, an escape ladder should be provided.

Draw arrows on the floorplan to show escape routes from each room.

Decide where to meet

Prearrange a meeting place outside and away from where emergency personnel are likely to be working. A neighbor's house or across the street in the front of the house are good locations. Always perform a head count to make sure all occupants safely exited. **NEVER ENTER A BURNING BUILDING.** If the head count shows one or more persons missing, give this information immediately to the authorities. Never enter a building to look for someone.

Practice your escape plans

Devising an escape plan is only the beginning, before the plan can be effective everyone should practice the escape routes from each room.

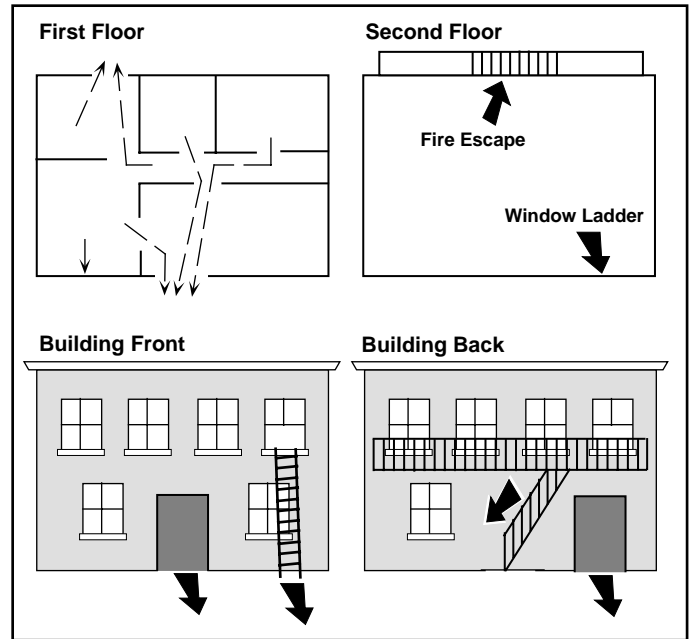

Early detection

The best way to survive a fire or other emergency is to get out early. The installation of a fire alarm system, with smoke and carbon monoxide detectors in each room, can greatly decrease your risk of loss or injury.

Emergency Evacuation Plans

The National Fire Protection Association recommends that you establish an emergency evacuation plan to safeguard lives in the event of a fire or other emergency. Use the following steps as a guide.

Draw a floorplan of your home or business

On a clean sheet of paper, draw the walls, windows, doors, and stairs. Also draw any obstacles that a person may encounter while exiting the building such as large furniture or appliances.

Develop escape routes

Determine at least two routes the occupants in each room can take to safely escape. One route can be the most obvious such as the door. Another can be through a window that can be easily opened. If the window is high off the ground, an escape ladder should be provided.

Draw arrows on the floorplan to show escape routes from each room.

Decide where to meet

Prearrange a meeting place outside and away from where emergency personnel are likely to be working. A neighbor's house or across the street in the front of the house are good locations. Always perform a head count to make sure all occupants safely exited. **NEVER ENTER A BURNING BUILDING.** If the head count shows one or more persons missing, give this information immediately to the authorities. Never enter a building to look for someone.

Practice your escape plans

Devising an escape plan is only the beginning, before the plan can be effective everyone should practice the escape routes from each room.

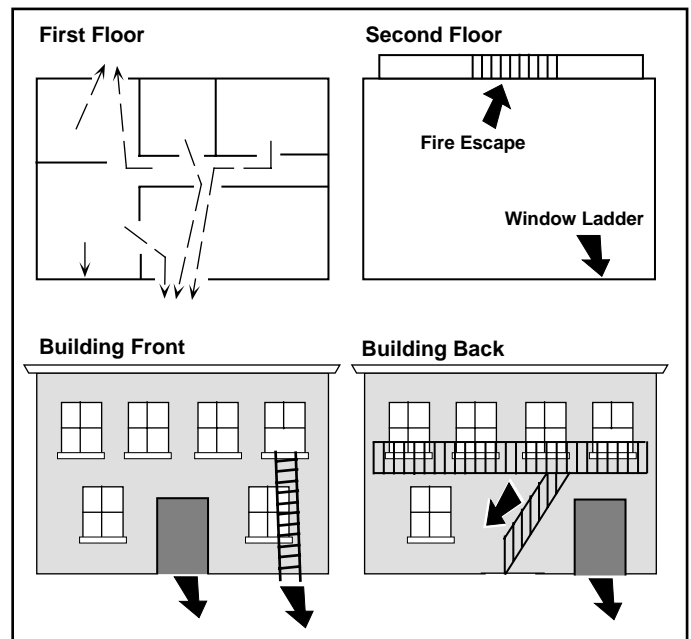

Early detection

The best way to survive a fire or other emergency is to get out early. The installation of a fire alarm system, with smoke and carbon monoxide detectors in each room, can greatly decrease your risk of loss or injury.

Introduction

About Your Security System

The Security Command system has been designed with your safety and comfort in mind. It uses the latest in computer based technology to create the most advanced, user friendly security, fire, and access control system available.

The Security Command system combines ease of use with a simple to understand Security Command keypad to offer the full range of features requested by today's security system owners. Security Command can protect both the interior and perimeter of your home or business while you're away or just the perimeter when you're inside.

You can turn portions of your protection on or off at any time by pressing a few keys, or have the system turn on or off automatically, every day, by entering a simple schedule. You can add, delete, and change personal user codes at any time or check the status of protection devices in the system.

Parts of the System

There are two main parts to the Security Command system, the Security Command keypad and the keypad User Menu.

Security Command keypad

This is the device we've placed at certain locations throughout the premises that allow you to turn the system's protection on and off using your personal user code.

Keypad User Menu

The keypad also provides a simple User Menu containing all of the functions you need to fully operate your system such as changing the time of day or a personal user code.

A Note About False Alarms

One of the most important concerns facing the security industry today is false alarms. The accidental dispatching of police and fire agencies places others in jeopardy by limiting the response capability of those emergency service units. We take this concern seriously and have spent many hours training our employees to recognize the causes of false alarms and prevent them from occurring.

As part of our commitment to reducing false alarms, we'd like to encourage you to read this guide thoroughly. All the information contained here can help you quickly, and comfortably, learn the operation of the Security Command system. If you have any additional questions, or feel that you need more training, please don't hesitate to contact us.

Test Your System Weekly

It is recommended that you test the burglary portion of your system at least once each week. Testing should involve an active test of all doors, windows, and motion detectors connected to your system. If your system also has fire protection, call the service department to find out how this portion of your system should be tested.

Refer to the System Test section of this guide for instructions on testing the burglary portion of your system.

Introduction

About Your Security System

The Security Command system has been designed with your safety and comfort in mind. It uses the latest in computer based technology to create the most advanced, user friendly security, fire, and access control system available.

The Security Command system combines ease of use with a simple to understand Security Command keypad to offer the full range of features requested by today's security system owners. Security Command can protect both the interior and perimeter of your home or business while you're away or just the perimeter when you're inside.

You can turn portions of your protection on or off at any time by pressing a few keys, or have the system turn on or off automatically, every day, by entering a simple schedule. You can add, delete, and change personal user codes at any time or check the status of protection devices in the system.

Parts of the System

There are two main parts to the Security Command system, the Security Command keypad and the keypad User Menu.

Security Command keypad

This is the device we've placed at certain locations throughout the premises that allow you to turn the system's protection on and off using your personal user code.

Keypad User Menu

The keypad also provides a simple User Menu containing all of the functions you need to fully operate your system such as changing the time of day or a personal user code.

A Note About False Alarms

One of the most important concerns facing the security industry today is false alarms. The accidental dispatching of police and fire agencies places others in jeopardy by limiting the response capability of those emergency service units. We take this concern seriously and have spent many hours training our employees to recognize the causes of false alarms and prevent them from occurring.

As part of our commitment to reducing false alarms, we'd like to encourage you to read this guide thoroughly. All the information contained here can help you quickly, and comfortably, learn the operation of the Security Command system. If you have any additional questions, or feel that you need more training, please don't hesitate to contact us.

Test Your System Weekly

It is recommended that you test the burglary portion of your system at least once each week. Testing should involve an active test of all doors, windows, and motion detectors connected to your system. If your system also has fire protection, call the service department to find out how this portion of your system should be tested.

Refer to the System Test section of this guide for instructions on testing the burglary portion of your system.

The Security Command Keypad

Your system may have one or more easy to use Security Command keypads (16 or 32 character) that allow you to properly operate the system. The illustration and descriptions below highlight some of the keypad features:

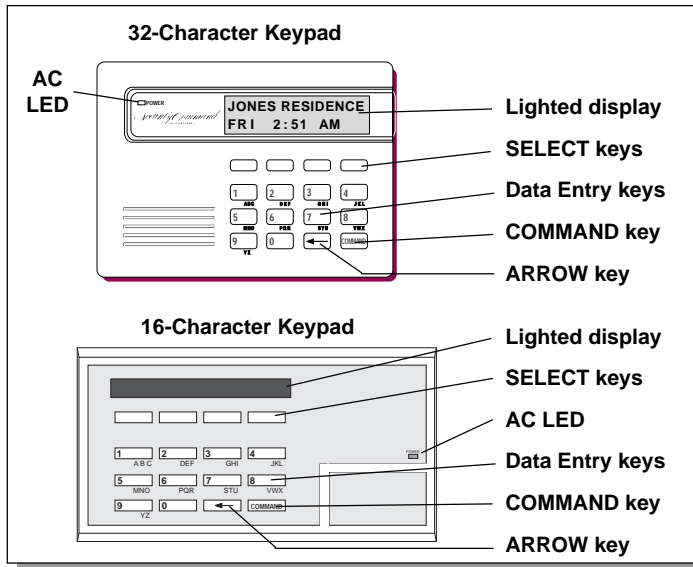

The SELECT keys

There are four keys under the display called the SELECT keys. These keys are one of the features that make your system so easy to operate. They allow you to choose what to do by pressing the SELECT key under choices being shown in the display.

2 Introduction

The Security Command Keypad

Your system may have one or more easy to use Security Command keypads (16 or 32 character) that allow you to properly operate the system. The illustration and descriptions below highlight some of the keypad features:

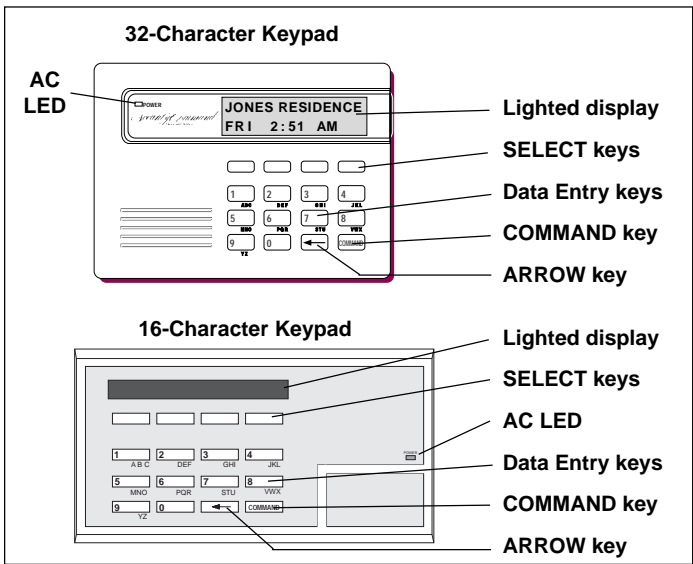

The SELECT keys

There are four keys under the display called the SELECT keys. These keys are one of the features that make your system so easy to operate. They allow you to choose what to do by pressing the SELECT key under choices being shown in the display.

2 Introduction

Data Entry keys

These keys allow you to enter your user code when arming or disarming or enter other information into the system.

The ARROW key

The ARROW key is used to go back through the keypad displays while operating your system. You can press the ARROW key to back up through the list of functions in the User Menu or to make a correction by erasing the last character you entered.

The COMMAND key

The COMMAND key allows you to advance through the keypad displays or User Menu or complete a data entry function.

AC LED

This LED remains on steady as long as your system is connected to its AC power supply. Should there be an interruption, the LED turns off and the system's backup battery maintains normal operation for a time allowing you to contact our service department.

32-Character Keypad User Options Menu

Press and hold the ARROW and COMMAND keys for about two seconds. The keypad display shows **SET BRIGHTNESS**. Use the left SELECT key to lower the display brightness. Use the right SELECT key to increase the display brightness. Press COMMAND.

At **SET TONE**, use the left SELECT key to lower the keypad tone. Use the right SELECT key to raise the keypad tone. Press COMMAND.

At **SET VOLUME LEVEL**, use the left SELECT key to lower the keypad volume. Use the right SELECT key to raise the keypad volume. Press COMMAND.

At **MODEL NUMBER**, the model number of the keypad is displayed. Press the ARROW key to exit out of the User Options menu.

Data Entry keys

These keys allow you to enter your user code when arming or disarming or enter other information into the system.

The ARROW key

The ARROW key is used to go back through the keypad displays while operating your system. You can press the ARROW key to back up through the list of functions in the User Menu or to make a correction by erasing the last character you entered.

The COMMAND key

The COMMAND key allows you to advance through the keypad displays or User Menu or complete a data entry function.

AC LED

This LED remains on steady as long as your system is connected to its AC power supply. Should there be an interruption, the LED turns off and the system's backup battery maintains normal operation for a time allowing you to contact our service department.

32-Character Keypad User Options Menu

Press and hold the ARROW and COMMAND keys for about two seconds. The keypad display shows **SET BRIGHTNESS**. Use the left SELECT key to lower the display brightness. Use the right SELECT key to increase the display brightness. Press COMMAND.

At **SET TONE**, use the left SELECT key to lower the keypad tone. Use the right SELECT key to raise the keypad tone. Press COMMAND.

At **SET VOLUME LEVEL**, use the left SELECT key to lower the keypad volume. Use the right SELECT key to raise the keypad volume. Press COMMAND.

At **MODEL NUMBER**, the model number of the keypad is displayed. Press the ARROW key to exit out of the User Options menu.

Special Security Command Displays

As you use your system, you'll occasionally see a keypad display that asks you to enter a code or that describes a condition on the system. Below are some examples of the displays you'll see:

ALARM

A 24 hour zone (for example fire or panic) or an armed burglary zone has been tripped. Your system may sound bells or sirens.

TROUBLE

There is a problem with a protection device or system component. This display is accompanied by a description of the problem.

ENTER CODE

The system requires you to enter your user code. User codes can be required for turning your system on (arming), turning your system off (disarming), and many other functions.

As you enter your user code, the keypad display shows an asterisk (*) in place of each digit pressed. This keeps others from seeing your user code on the display as it's entered.

TRY AGAIN or INVALID CODE

The user code you've entered is not recognized by the system. Check the user code and try again.

INVALID LEVEL

All user codes have authority levels that allow the user to only access certain functions. When a user attempts a function outside their authority, the **INVALID LEVEL** message displays.

Special Security Command Displays

As you use your system, you'll occasionally see a keypad display that asks you to enter a code or that describes a condition on the system. Below are some examples of the displays you'll see:

ALARM

A 24 hour zone (for example fire or panic) or an armed burglary zone has been tripped. Your system may sound bells or sirens.

TROUBLE

There is a problem with a protection device or system component. This display is accompanied by a description of the problem.

ENTER CODE

The system requires you to enter your user code. User codes can be required for turning your system on (arming), turning your system off (disarming), and many other functions.

As you enter your user code, the keypad display shows an asterisk (*) in place of each digit pressed. This keeps others from seeing your user code on the display as it's entered.

TRY AGAIN or INVALID CODE

The user code you've entered is not recognized by the system. Check the user code and try again.

INVALID LEVEL

All user codes have authority levels that allow the user to only access certain functions. When a user attempts a function outside their authority, the **INVALID LEVEL** message displays.

INVALID TIME

A level 1 or 2 user code has been entered outside of the valid schedule. See Schedules and User Codes.

SYSTEM TROUBLE or SERVICE REQUIRED

There is a problem with one or more of the components in your system. Contact our service department as soon as possible.

SYSTEM BUSY

The Security Command system is performing another task of a higher priority. This usually only takes a few moments.

Special Wireless Displays

Your system may use radio transmitters to send alarm and trouble information from the protection devices to the panel. Wireless systems operate the same as hardwired and also have a few unique keypad displays.

BACK DOOR - LOBAT – (Low Battery) The battery in a radio transmitter is low. (BACK DOOR is used as an example only.)

BACK DOOR - MISNG - (Missing) The panel is not receiving the radio transmitter's periodic test report.

WIRELESS - TRBL - (Trouble) Some part of your wireless system is operating improperly. Test the system to locate the trouble.

INVALID TIME

A level 1 or 2 user code has been entered outside of the valid schedule. See Schedules and User Codes.

SYSTEM TROUBLE or SERVICE REQUIRED

There is a problem with one or more of the components in your system. Contact our service department as soon as possible.

SYSTEM BUSY

The Security Command system is performing another task of a higher priority. This usually only takes a few moments.

Special Wireless Displays

Your system may use radio transmitters to send alarm and trouble information from the protection devices to the panel. Wireless systems operate the same as hardwired and also have a few unique keypad displays.

BACK DOOR - LOBAT – (Low Battery) The battery in a radio transmitter is low. (BACK DOOR is used as an example only.)

BACK DOOR - MISNG - (Missing) The panel is not receiving the radio transmitter's periodic test report.

WIRELESS - TRBL - (Trouble) Some part of your wireless system is operating improperly. Test the system to locate the trouble.

Special Security Command Tones

Your keypad also contains a small speaker that allows it to alert you to events as they occur on your system. Below are brief descriptions of the different tones you'll hear from the keypad:

Fire Alarm tone: An intermittent sweeping siren that sounds until the fire alarm is silenced, on LCD keypads only.

Burglary Alarm tone: A constant siren tone at maximum volume that continues until the alarm is silenced, on LCD keypads only.

Key press tone: A short beep each time you press a key on the keypad and it's acknowledged by the system.

Prewarn tone: A continuous pulsed tone that sounds when you open an entry delay door on a system that is armed (turned on) reminding you to disarm the burglary protection.

Monitor tone: A pulsed tone for one second, one pulse only that sounds whenever a door or window is opened while you're using the zone monitor function from the User Menu. LCD keypads sound a door bell chime. See Zone Monitor.

Trouble tone: A steady tone indicating a trouble condition on your system. Press a SELECT key to silence.

What to do when the trouble tone is sounding

You can silence the trouble tone by pressing any one of the top row SELECT keys. This only silences the keypad and does not correct the condition that originally caused the trouble.

4 Introduction

Special Security Command Tones

Your keypad also contains a small speaker that allows it to alert you to events as they occur on your system. Below are brief descriptions of the different tones you'll hear from the keypad:

Fire Alarm tone: An intermittent sweeping siren that sounds until the fire alarm is silenced, on LCD keypads only.

Burglary Alarm tone: A constant siren tone at maximum volume that continues until the alarm is silenced, on LCD keypads only.

Key press tone: A short beep each time you press a key on the keypad and it's acknowledged by the system.

Prewarn tone: A continuous pulsed tone that sounds when you open an entry delay door on a system that is armed (turned on) reminding you to disarm the burglary protection.

Monitor tone: A pulsed tone for one second, one pulse only that sounds whenever a door or window is opened while you're using the zone monitor function from the User Menu. LCD keypads sound a door bell chime. See Zone Monitor.

Trouble tone: A steady tone indicating a trouble condition on your system. Press a SELECT key to silence.

What to do when the trouble tone is sounding

You can silence the trouble tone by pressing any one of the top row SELECT keys. This only silences the keypad and does not correct the condition that originally caused the trouble.

4 Introduction

Understanding Security System Terms

Throughout this guide, and in some displays on your keypad, you'll see certain words or phrases that might be unfamiliar. Although every effort has been made to use terms that are commonly known, there are some for which there was no acceptable substitute.

Below are some terms you'll see here and on your keypad display:

Arming

This is the term used for turning on the burglary protection in one or more areas of the system. Your system may require you to enter a user code. When armed, the system is able to sound alarm bells or sirens and, if monitored, send alarm reports to a central station when a burglary zone is tripped.

Fire, panic, and other 24 hour devices are always turned on and do not need to be armed.

Disarming

This means turning off one or more areas of the system. When disarmed, the system does NOT sound alarms or send alarm reports to a central station when a burglary zone is faulted.

Zone

A zone refers to one or more protected openings (doors or windows) or protection devices (motion or glassbreak detectors) grouped together under the same zone name and number.

Often, similar devices in the same general area will share the same zone. For example, the windows on the east side of the premises can all be grouped together in a zone named **E. WINDOWS**.

Understanding Security System Terms

Throughout this guide, and in some displays on your keypad, you'll see certain words or phrases that might be unfamiliar. Although every effort has been made to use terms that are commonly known, there are some for which there was no acceptable substitute.

Below are some terms you'll see here and on your keypad display:

Arming

This is the term used for turning on the burglary protection in one or more areas of the system. Your system may require you to enter a user code. When armed, the system is able to sound alarm bells or sirens and, if monitored, send alarm reports to a central station when a burglary zone is tripped.

Fire, panic, and other 24 hour devices are always turned on and do not need to be armed.

Disarming

This means turning off one or more areas of the system. When disarmed, the system does NOT sound alarms or send alarm reports to a central station when a burglary zone is faulted.

Zone

A zone refers to one or more protected openings (doors or windows) or protection devices (motion or glassbreak detectors) grouped together under the same zone name and number.

Often, similar devices in the same general area will share the same zone. For example, the windows on the east side of the premises can all be grouped together in a zone named **E. WINDOWS**.

Understanding Security System Terms

Entry or Exit zone

Almost all systems have one or more doors through which you can enter or exit the premises. These doors are programmed with a delay time to allow you to enter or exit without setting off the alarm.

When you arm the system, activity on this zone is ignored until the programmed exit delay time expires. Once that time has expired and the system is fully armed, opening the door causes the panel to start the *entry* delay time. During the entry delay time, you must enter a valid user code to disarm the system or an alarm will occur.

Instant Zone

Exterior windows and non entry doors, or interior protection devices, are typically not programmed with delay times. If these zones are tripped while the system is armed, an alarm occurs instantly.

24 Hour Zone

A 24 hour zone is not turned on or off by arming or disarming your system. Some examples of 24 hour zones are: fire zones, panic zones, and temperature control zones.

Areas

An area is made up of burglary zones that can be armed or disarmed together. One area might consist of the office doors and windows. When you arm the office, these zones arm together and sound an alarm if opened.

Central Station Monitoring

Your system can also be programmed to automatically send alarm, trouble, and arming and disarming reports to a central station. Operators at the central station can in turn dispatch the appropriate authorities or contact you with the specific event information.

Understanding Security System Terms

Entry or Exit zone

Almost all systems have one or more doors through which you can enter or exit the premises. These doors are programmed with a delay time to allow you to enter or exit without setting off the alarm.

When you arm the system, activity on this zone is ignored until the programmed exit delay time expires. Once that time has expired and the system is fully armed, opening the door causes the panel to start the *entry* delay time. During the entry delay time, you must enter a valid user code to disarm the system or an alarm will occur.

Instant Zone

Exterior windows and non entry doors, or interior protection devices, are typically not programmed with delay times. If these zones are tripped while the system is armed, an alarm occurs instantly.

24 Hour Zone

A 24 hour zone is not turned on or off by arming or disarming your system. Some examples of 24 hour zones are: fire zones, panic zones, and temperature control zones.

Areas

An area is made up of burglary zones that can be armed or disarmed together. One area might consist of the office doors and windows. When you arm the office, these zones arm together and sound an alarm if opened.

Central Station Monitoring

Your system can also be programmed to automatically send alarm, trouble, and arming and disarming reports to a central station. Operators at the central station can in turn dispatch the appropriate authorities or contact you with the specific event information.

Status

Status is a feature that automatically displays the armed or disarmed status of your system on the Security Command keypads. Alarm or trouble conditions on a zone or a system monitor such as AC or battery trouble can also be displayed. There are two types of status information available: **Armed Status** and **Status List**.

Armed Status

With Armed Status, the keypad displays the current armed condition of areas within your security system. For example:

When you arm areas 1 to 4, the keypad shows = **1 2 3 4**

When you arm areas 1 and 3, the keypad shows = **1 3**

If your system is setup as an All/Perimeter or Home/Away system and both the interior and perimeter is armed the display reads:

ALL SYSTEM ON

Status List

The keypad Status List displays any alarm or trouble condition on a zone, and any trouble condition on an internal system monitor. The system monitors include the AC power, battery power, panel box tamper, printer, and phone lines. If more than one alarm or trouble condition occurs at the same time, the keypad sequences this information on its display.

If the alarm is from a 24 hour zone or a system monitor, it remains in the Status List until it restores. If one or more armed burglary zones trip at the same time, the last one to trip remains in the Status List. This is to ensure that if a burglary has occurred the last zone tripped remains displayed even if it has been restored.

Introduction **5**

Status

Status is a feature that automatically displays the armed or disarmed status of your system on the Security Command keypads. Alarm or trouble conditions on a zone or a system monitor such as AC or battery trouble can also be displayed. There are two types of status information available: **Armed Status** and **Status List**.

Armed Status

With Armed Status, the keypad displays the current armed condition of areas within your security system. For example:

When you arm areas 1 to 4, the keypad shows = **1 2 3 4**

When you arm areas 1 and 3, the keypad shows = **1 3**

If your system is setup as an All/Perimeter or Home/Away system and both the interior and perimeter is armed the display reads:

ALL SYSTEM ON

Status List

The keypad Status List displays any alarm or trouble condition on a zone, and any trouble condition on an internal system monitor. The system monitors include the AC power, battery power, panel box tamper, printer, and phone lines. If more than one alarm or trouble condition occurs at the same time, the keypad sequences this information on its display.

If the alarm is from a 24 hour zone or a system monitor, it remains in the Status List until it restores. If one or more armed burglary zones trip at the same time, the last one to trip remains in the Status List. This is to ensure that if a burglary has occurred the last zone tripped remains displayed even if it has been restored.

Introduction **5**

General Arming Operation

Your system has been programmed to operate in one of three modes: Area Arming, All/Perimeter, or Home/Away.

- **Area Arming** - Your burglary protection is divided into areas. Each area has a custom name, can be turned on or off independent of other areas, and can have different schedules and authorized users.

- **All/Perimeter** - Your burglary protection is divided into two areas, Interior and Perimeter. You can turn on the just the Perimeter protection while inside for security or turn on both as you leave.

- **Home/Away** - Perimeter, Interior, and a Bedrooms area you can leave turned off at night while you're sleeping.

Regardless of how your system has been programmed, much of the operation is similar. Throughout this guide, any differences between the systems are noted for your convenience.

Arming Functions

After making your arming selection, the keypad displays any zones that are currently bypassed. These zones remain bypassed until the system is armed and then disarmed. Any 24 hour zones in a bad condition are also displayed.

Before arming, the system verifies that all doors, windows, and other protection devices to be armed are in a normal condition. If everything is okay, the system arms. If there is a problem on one or more burglary zones the system cannot arm until the problem is corrected. If the problem is simply an open door or window, correct the problem and try arming again.

6 Introduction

General Arming Operation

Your system has been programmed to operate in one of three modes: Area Arming, All/Perimeter, or Home/Away.

- **Area Arming** - Your burglary protection is divided into areas. Each area has a custom name, can be turned on or off independent of other areas, and can have different schedules and authorized users.

- **All/Perimeter** - Your burglary protection is divided into two areas, Interior and Perimeter. You can turn on the just the Perimeter protection while inside for security or turn on both as you leave.

- **Home/Away** - Perimeter, Interior, and a Bedrooms area you can leave turned off at night while you're sleeping.

Regardless of how your system has been programmed, much of the operation is similar. Throughout this guide, any differences between the systems are noted for your convenience.

Arming Functions

After making your arming selection, the keypad displays any zones that are currently bypassed. These zones remain bypassed until the system is armed and then disarmed. Any 24 hour zones in a bad condition are also displayed.

Before arming, the system verifies that all doors, windows, and other protection devices to be armed are in a normal condition. If everything is okay, the system arms. If there is a problem on one or more burglary zones the system cannot arm until the problem is corrected. If the problem is simply an open door or window, correct the problem and try arming again.

6 Introduction

If the problem cannot be corrected, you can force arm or bypass the zone or wait until the zone can be repaired by a service technician. A **force armed** zone is ignored by the system until it restores to normal. A **bypassed** zone is ignored by the system during the entire armed period. A zone remains bypassed until the system is disarmed.

In some cases, you might see the keypad display **FRONT DOOR BAD ***. The asterisk next to **BAD** means that the zone is a priority zone, which cannot be bypassed. The problem on the zone must be corrected before the system can be armed.

Armed Message: After all bypassing is completed or zone faults corrected, the keypad briefly displays **ALL SYSTEM ON** if all areas in the system are arming and **SYSTEM ON** if only selected areas are arming. The keypad then displays the exit delay time as it counts down. When the exit delay time expires, all disarmed zones are armed.

If your system uses a keyswitch to arm an area, the exit delay time is NOT shown on the keypad display.

ONE MOMENT . . . Message: If your system is monitored, it may be programmed to wait for the transmission of an arming report to the central station before displaying the armed message. See Arming Report below. This is to verify your phone lines are working properly. While the system is waiting for the transmission, the display reads **ONE MOMENT....** If the report is received, the keypad displays the armed message. If the report is not received, the keypad displays **LOCAL ALARM ONLY** before displaying the armed message.

Arming Report: Your system can be programmed to send arming or zone bypassing reports to a central station. This feature is optional and can be programmed for you at any time.

If the problem cannot be corrected, you can force arm or bypass the zone or wait until the zone can be repaired by a service technician. A **force armed** zone is ignored by the system until it restores to normal. A **bypassed** zone is ignored by the system during the entire armed period. A zone remains bypassed until the system is disarmed.

In some cases, you might see the keypad display **FRONT DOOR BAD ***. The asterisk next to **BAD** means that the zone is a priority zone, which cannot be bypassed. The problem on the zone must be corrected before the system can be armed.

Armed Message: After all bypassing is completed or zone faults corrected, the keypad briefly displays **ALL SYSTEM ON** if all areas in the system are arming and **SYSTEM ON** if only selected areas are arming. The keypad then displays the exit delay time as it counts down. When the exit delay time expires, all disarmed zones are armed.

If your system uses a keyswitch to arm an area, the exit delay time is NOT shown on the keypad display.

ONE MOMENT . . . Message: If your system is monitored, it may be programmed to wait for the transmission of an arming report to the central station before displaying the armed message. See Arming Report below. This is to verify your phone lines are working properly. While the system is waiting for the transmission, the display reads **ONE MOMENT....** If the report is received, the keypad displays the armed message. If the report is not received, the keypad displays **LOCAL ALARM ONLY** before displaying the armed message.

Arming Report: Your system can be programmed to send arming or zone bypassing reports to a central station. This feature is optional and can be programmed for you at any time.

Area System Arming

Area Assignment: Your security system has been set up into separate areas. The number of areas and their names are listed in the back of this guide.

Arming or Disarming: You can arm and disarm all areas at one time or each area individually. You can only arm or disarm areas authorized for your user code.

Arm all or Selective Arming: After entering your user code, the system allows you to arm either all of the areas to which you have access or one or more selected areas. If you choose to arm all areas, the system begins verifying that all zones in those areas are in a good condition. If you choose to arm selected areas, the system prompts you to choose the areas you want to arm.

Arming the System:

1. Press the COMMAND key until **ARM DISARM** is displayed.
2. Select **ARM** to arm the system.
3. Enter your user code if required.
The display reads **ALL? NO YES**.
4. Select **NO** to arm only selected areas. Go to step 5. Select **YES** to arm all areas authorized for your user code. Go to step 6.
5. If you selected **NO** in step 4, the display begins to list each area to which you have access followed by **NO YES**.
Example: **OFFICE NO YES**
 - 5a. Select **YES** for each area you want to arm.
 - 5b. Select **NO** for each area you do not want to arm.

Area System Arming

Area Assignment: Your security system has been set up into separate areas. The number of areas and their names are listed in the back of this guide.

Arming or Disarming: You can arm and disarm all areas at one time or each area individually. You can only arm or disarm areas authorized for your user code.

Arm all or Selective Arming: After entering your user code, the system allows you to arm either all of the areas to which you have access or one or more selected areas. If you choose to arm all areas, the system begins verifying that all zones in those areas are in a good condition. If you choose to arm selected areas, the system prompts you to choose the areas you want to arm.

Arming the System:

1. Press the COMMAND key until **ARM DISARM** is displayed.
2. Select **ARM** to arm the system.
3. Enter your user code if required.
The display reads **ALL? NO YES**.
4. Select **NO** to arm only selected areas. Go to step 5. Select **YES** to arm all areas authorized for your user code. Go to step 6.
5. If you selected **NO** in step 4, the display begins to list each area to which you have access followed by **NO YES**.
Example: **OFFICE NO YES**
 - 5a. Select **YES** for each area you want to arm.
 - 5b. Select **NO** for each area you do not want to arm.

Note: You can also just press the area numbers you want to arm while at the **ALL? NO YES** display. This changes the display to **AREAS:**. The area numbers you select appear in the display. For example: **AREAS: 2 4**. Press COMMAND when done.

6. The system displays any bypassed zones or bad 24 hour or Priority zones. A bad Priority zone cannot be armed.
7. At this point you can **force arm** or **bypass** any bad zones. A zone that is force armed will be restored into the system if it later returns to normal. A zone that is bypassed will remain bypassed until the system is disarmed. See steps 7a through 7d.
 - 7a. If a problem exists on a zone, the zone name and problem is shown followed by: **OKAY BYPASS STOP**.
 - 7b. Select **OKAY** to force arm the bad zone.
 - 7c. Select **BYPASS** to bypass all bad zones being displayed.
 - 7d. Select **STOP** to stop the system from arming. Correct the zone problem(s) and return to step 1.
8. The display reads **SYSTEM ON** if at least one area in the system is armed, and **ALL SYSTEM ON** if all areas in the system are armed.
9. The keypad then displays the exit time in seconds and counts down the remaining time: **EXIT : ## (## = seconds remaining)**. The exit zones arm when the delay time expires.

Note: You can also just press the area numbers you want to arm while at the **ALL? NO YES** display. This changes the display to **AREAS:**. The area numbers you select appear in the display. For example: **AREAS: 2 4**. Press COMMAND when done.

6. The system displays any bypassed zones or bad 24 hour or Priority zones. A bad Priority zone cannot be armed.
7. At this point you can **force arm** or **bypass** any bad zones. A zone that is force armed will be restored into the system if it later returns to normal. A zone that is bypassed will remain bypassed until the system is disarmed. See steps 7a through 7d.
 - 7a. If a problem exists on a zone, the zone name and problem is shown followed by: **OKAY BYPASS STOP**.
 - 7b. Select **OKAY** to force arm the bad zone.
 - 7c. Select **BYPASS** to bypass all bad zones being displayed.
 - 7d. Select **STOP** to stop the system from arming. Correct the zone problem(s) and return to step 1.
8. The display reads **SYSTEM ON** if at least one area in the system is armed, and **ALL SYSTEM ON** if all areas in the system are armed.
9. The keypad then displays the exit time in seconds and counts down the remaining time: **EXIT : ## (## = seconds remaining)**. The exit zones arm when the delay time expires.

Area System Disarming

Disarming: While the system is armed, you can only enter the premises through an entry/exit delay door without causing an alarm. After opening the door, the Security Command keypad sounds a prewarn tone to remind you to disarm the system. You must disarm the system before the entry delay time expires or an alarm on the door zone will occur.

During the entry delay time, the keypad displays **ENTER CODE:**. Enter your code to disarm the system. Only those areas assigned to your code will disarm.

Schedules: If you've programmed schedules for your system and a level 2 code is entered outside of a schedule, the keypad displays **INVALID TIME**. This lets the user know that they are disarming outside of their authorized time. If your system is monitored, an Unauthorized Entry report is sent to the central station.

All or Selective Disarming: After entering your user code, the system allows you to disarm either all of the areas to which you have access or just selected areas. If you choose to disarm all areas, the system automatically disarms them. If you choose to disarm selected areas, the names of those areas will be displayed on the keypad.

Alarm Display: After disarming, the keypad displays any zones that tripped or any transmission problems that occurred during the armed period. All burglary zones are then disarmed and any bypassed zones are automatically reset.

Disarmed Message: The keypad displays **ALL SYSTEM OFF** after the system disarms.

Central Station Report: A report of the system disarming can be transmitted to the central station. This is optional and can be programmed for you at any time.

Disarming an Area System

1. Press the COMMAND key until **ARM DISARM** is displayed. During entry delay this process starts at step 3.
2. Select **DISARM** to disarm areas.
3. The keypad displays **ENTER CODE:**. Enter your user code and press COMMAND. The keypad displays **ALL? NO YES**.
4. Select **YES** to disarm all areas authorized for your user code. Select **NO** to disarm only certain areas individually. The keypad then displays the name of each area authorized for your user code followed by the **NO YES** display.
Choose **YES** to disarm the area displayed.
Choose **NO** to not disarm and to display the next area.

Note: You can also just press the area numbers you want to disarm while at the **ALL? NO YES** display. This changes the display to **AREAS:**. The area numbers you select appear in the display. For example: **AREAS: 2 4**. Press COMMAND when done.

5. After all areas have been displayed, any alarms or communication problems that occurred during the armed period are displayed.
6. If all areas have been disarmed, the keypad next displays **ALL SYSTEM OFF**.

8 Arming and Disarming

Area System Disarming

Disarming: While the system is armed, you can only enter the premises through an entry/exit delay door without causing an alarm. After opening the door, the Security Command keypad sounds a prewarn tone to remind you to disarm the system. You must disarm the system before the entry delay time expires or an alarm on the door zone will occur.

During the entry delay time, the keypad displays **ENTER CODE:**. Enter your code to disarm the system. Only those areas assigned to your code will disarm.

Schedules: If you've programmed schedules for your system and a level 2 code is entered outside of a schedule, the keypad displays **INVALID TIME**. This lets the user know that they are disarming outside of their authorized time. If your system is monitored, an Unauthorized Entry report is sent to the central station.

All or Selective Disarming: After entering your user code, the system allows you to disarm either all of the areas to which you have access or just selected areas. If you choose to disarm all areas, the system automatically disarms them. If you choose to disarm selected areas, the names of those areas will be displayed on the keypad.

Alarm Display: After disarming, the keypad displays any zones that tripped or any transmission problems that occurred during the armed period. All burglary zones are then disarmed and any bypassed zones are automatically reset.

Disarmed Message: The keypad displays **ALL SYSTEM OFF** after the system disarms.

Central Station Report: A report of the system disarming can be transmitted to the central station. This is optional and can be programmed for you at any time.

Disarming an Area System

1. Press the COMMAND key until **ARM DISARM** is displayed. During entry delay this process starts at step 3.
2. Select **DISARM** to disarm areas.
3. The keypad displays **ENTER CODE:**. Enter your user code and press COMMAND. The keypad displays **ALL? NO YES**.
4. Select **YES** to disarm all areas authorized for your user code. Select **NO** to disarm only certain areas individually. The keypad then displays the name of each area authorized for your user code followed by the **NO YES** display.
Choose **YES** to disarm the area displayed.
Choose **NO** to not disarm and to display the next area.

Note: You can also just press the area numbers you want to disarm while at the **ALL? NO YES** display. This changes the display to **AREAS:**. The area numbers you select appear in the display. For example: **AREAS: 2 4**. Press COMMAND when done.

5. After all areas have been displayed, any alarms or communication problems that occurred during the armed period are displayed.
6. If all areas have been disarmed, the keypad next displays **ALL SYSTEM OFF**.

8 Arming and Disarming

All/Perimeter System Arming

Area Assignment: Your security system is divided into two separate areas. Motion detectors, inside doors, and other interior protection devices are assigned to the *Interior* area while windows and exterior doors are assigned to the *Perimeter* area.

Perimeter or All: When you go to arm an All/Perimeter system, the Security Command keypad displays **PERIM ALL**. If you select **ALL**, you're arming both the Perimeter and the Interior areas of the system. You'll want to arm both of these areas when leaving the premises with nobody left inside. Selecting **PERIM** arms only the perimeter of the system. Perimeter arming is for when you're staying inside but want the comfort of knowing the exterior doors and windows are armed. Perimeter arming allows you to move freely about inside without setting off any interior alarms.

Instant: During the exit delay time, you can cancel the exit and entry delays and cause all zones to be instant zones. Just press the far right SELECT key under **INSTNT** while the exit delay is displayed. This immediately arms the exit zones. However, no entry delay is provided and an alarm will occur should an entry door be opened.

Arming an All/Perimeter System

1. Press the COMMAND key until **PERIM ALL** is displayed.
2. Select **ALL** to arm both the perimeter and interior areas. Press **PERIM** to arm the perimeter area only.
3. Enter your user code if required.

All/Perimeter System Arming

Area Assignment: Your security system is divided into two separate areas. Motion detectors, inside doors, and other interior protection devices are assigned to the *Interior* area while windows and exterior doors are assigned to the *Perimeter* area.

Perimeter or All: When you go to arm an All/Perimeter system, the Security Command keypad displays **PERIM ALL**. If you select **ALL**, you're arming both the Perimeter and the Interior areas of the system. You'll want to arm both of these areas when leaving the premises with nobody left inside. Selecting **PERIM** arms only the perimeter of the system. Perimeter arming is for when you're staying inside but want the comfort of knowing the exterior doors and windows are armed. Perimeter arming allows you to move freely about inside without setting off any interior alarms.

Instant: During the exit delay time, you can cancel the exit and entry delays and cause all zones to be instant zones. Just press the far right select key under **INSTNT** while the exit delay is displayed. This immediately arms the exit zones. However, no entry delay is provided and an alarm will occur should an entry door be opened.

Arming an All/Perimeter System

1. Press the COMMAND key until **PERIM ALL** is displayed.
2. Select **ALL** to arm both the perimeter and interior areas. Press **PERIM** to arm the perimeter area only.
3. Enter your user code if required.

4. The system displays any Bypassed zones or bad 24 hour or Priority zones. A bad Priority zone cannot be armed.
5. At this point you can **force arm** or **bypass** any bad zones. A zone that is force armed will be restored into the system if it later returns to normal. A zone that is bypassed will remain bypassed until the system is disarmed. See steps 5a through 5d.
 - 5a. If a problem exists on a zone, the zone name and problem is shown followed by **OKAY BYPASS STOP**.
 - 5b. Select **OKAY** to force arm the zone(s) before arming.
 - 5c. Select **BYPASS** to bypass the zone(s) before arming.
 - 5d. Select **STOP** to stop the system from arming. Correct the zone problem(s) and return to step 1.
6. The keypad displays **PERIMETER ON** if only the perimeter is being armed and **ALL SYSTEM ON** if both the perimeter and interior are being armed.
7. The keypad next displays **EXIT: ## INSTNT** and begins to count down the number of seconds remaining for you to exit. When the delay expires, the exit zones are armed.
8. You can select **INSTNT** while **EXIT: ## INSTNT** is displayed to immediately arm all exit zones and make them instant. The keypad displays **INSTANT**.
9. When the system is fully armed, the keypad displays **PERIMETER ON** for perimeter arming and **ALL SYSTEM ON** for perimeter and interior arming.

4. The system displays any Bypassed zones or bad 24 hour or Priority zones. A bad Priority zone cannot be armed.
5. At this point you can **force arm** or **bypass** any bad zones. A zone that is force armed will be restored into the system if it later returns to normal. A zone that is bypassed will remain bypassed until the system is disarmed. See steps 5a through 5d.
 - 5a. If a problem exists on a zone, the zone name and problem is shown followed by **OKAY BYPASS STOP**.
 - 5b. Select **OKAY** to force arm the zone(s) before arming.
 - 5c. Select **BYPASS** to bypass the zone(s) before arming.
 - 5d. Select **STOP** to stop the system from arming. Correct the zone problem(s) and return to step 1.
6. The keypad displays **PERIMETER ON** if only the perimeter is being armed and **ALL SYSTEM ON** if both the perimeter and interior are being armed.
7. The keypad next displays **EXIT: ## INSTNT** and begins to count down the number of seconds remaining for you to exit. When the delay expires, the exit zones are armed.
8. You can select **INSTNT** while **EXIT: ## INSTNT** is displayed to immediately arm all exit zones and make them instant. The keypad displays **INSTANT**.
9. When the system is fully armed, the keypad displays **PERIMETER ON** for perimeter arming and **ALL SYSTEM ON** for perimeter and interior arming.

All/Perimeter System Disarming

Disarming: While the system is armed, you can only enter the premises through an entry/exit delay door without causing an alarm. After opening the door, the Security Command keypad sounds a prewarn tone to remind you to disarm the system. You must disarm the system before the prewarn tone expires or an alarm on the door zone will occur.

During the prewarn tone, the keypad displays **ENTER CODE:**. Enter your code to disarm the system.

Schedules: If you've programmed schedules for your system and a level 2 code is entered outside of a schedule, the keypad displays **INVALID TIME**. This lets the user know that they are disarming outside of their authorized time. If your system is monitored, an Unauthorized Entry report is sent to the central station.

Alarm Display: After disarming, the keypad displays any zones that tripped or any transmission problems that occurred during the armed period. All burglary zones are then disarmed and any bypassed zones are automatically reset.

Disarmed Message: The keypad displays **ALL SYSTEM OFF** after the system disarms.

Central Station Report: A report of the system disarming can be transmitted to the central station. This is optional and can be programmed for you at any time.

Disarming an All/Perimeter System

1. During the entry delay time, the keypad displays **ENTER CODE:** . Enter your user code and press COMMAND.
2. The keypad then displays any zones that went into alarm or any communication problems that occurred during the armed period.
3. The keypad next displays **ALL SYSTEM OFF** to confirm the system is disarmed.

Disarming During an Alarm

1. While the alarm bell or siren is sounding, enter your user code and press COMMAND. The keypad displays **DISARM SILENCE**.
2. Press the SELECT key under **DISARM** to disarm the system and silence the alarm.

The keypad next displays **ALL SYSTEM OFF** to confirm the system is disarmed.

3. Press the SELECT key under **SILENCE** to stop the bell or siren but NOT disarm the system.

If you do not press any SELECT key, or you press the COMMAND key, the system will automatically disarm and silence the alarm.

4. If your system is programmed to send an Abort (alarm cancel) report to the central station, the keypad displays **ALARM CANCELLED**.

10 Arming and Disarming

All/Perimeter System Disarming

Disarming: While the system is armed, you can only enter the premises through an entry/exit delay door without causing an alarm. After opening the door, the Security Command keypad sounds a prewarn tone to remind you to disarm the system. You must disarm the system before the prewarn tone expires or an alarm on the door zone will occur.

During the prewarn tone, the keypad displays **ENTER CODE:**. Enter your code to disarm the system.

Schedules: If you've programmed schedules for your system and a level 2 code is entered outside of a schedule, the keypad displays **INVALID TIME**. This lets the user know that they are disarming outside of their authorized time. If your system is monitored, an Unauthorized Entry report is sent to the central station.

Alarm Display: After disarming, the keypad displays any zones that tripped or any transmission problems that occurred during the armed period. All burglary zones are then disarmed and any bypassed zones are automatically reset.

Disarmed Message: The keypad displays **ALL SYSTEM OFF** after the system disarms.

Central Station Report: A report of the system disarming can be transmitted to the central station. This is optional and can be programmed for you at any time.

Disarming an All/Perimeter System

1. During the entry delay time, the keypad displays **ENTER CODE:** . Enter your user code and press COMMAND.
2. The keypad then displays any zones that went into alarm or any communication problems that occurred during the armed period.
3. The keypad next displays **ALL SYSTEM OFF** to confirm the system is disarmed.

Disarming During an Alarm

1. While the alarm bell or siren is sounding, enter your user code and press COMMAND. The keypad displays **DISARM SILENCE**.
2. Press the SELECT key under **DISARM** to disarm the system and silence the alarm.

The keypad next displays **ALL SYSTEM OFF** to confirm the system is disarmed.

3. Press the SELECT key under **SILENCE** to stop the bell or siren but NOT disarm the system.

If you do not press any SELECT key, or you press the COMMAND key, the system will automatically disarm and silence the alarm.

4. If your system is programmed to send an Abort (alarm cancel) report to the central station, the keypad displays **ALARM CANCELLED**.

10 Arming and Disarming

Home/Away System Arming

Area Assignment: Your security system is divided into two or three separate areas. Motion detectors, inside doors, and other interior devices are assigned to an *Interior* and possibly *Bedroom* area while windows and exterior doors, are assigned to a *Perimeter* area.

Arming the system: When arming a Home/Away system, the keypad displays **HOME AWAY** or **HOME SLEEP AWAY**. If you select **AWAY**, you arm all areas of the system. You'll want to arm all areas when leaving with nobody staying inside. Selecting **HOME** arms only the Perimeter of the system. Perimeter arming is for when you're staying inside but want the comfort of knowing the exterior doors and windows are armed. Perimeter arming allows you to move freely about inside without setting off any interior alarms.

Selecting **SLEEP** arms the Perimeter and Interior devices but leaves devices near bedrooms or other nighttime areas off.

System Ready/System Not Ready Keypad Displays

When all zones in the system are in a normal condition and can be armed without bypassing, the keypad displays **SYSTEM READY**. If there are one or more zones that are not in a normal condition, the keypad displays **SYSTEM NOT READY**. Pressing any top row SELECT key during this display shows the zone number and name allowing you to investigate the problem.

Arming a Home/Away System

1. Enter a 2 to 3 digit code and press the COMMAND key or enter a 4 digit code without pressing the COMMAND key. The keypad displays **HOME AWAY** or **HOME SLEEP AWAY** (your system may have two or three areas).
2. Select **HOME** to arm the Perimeter only.

Home/Away System Arming

Area Assignment: Your security system is divided into two or three separate areas. Motion detectors, inside doors, and other interior devices are assigned to an *Interior* and possibly *Bedroom* area while windows and exterior doors, are assigned to a *Perimeter* area.

Arming the system: When arming a Home/Away system, the keypad displays **HOME AWAY** or **HOME SLEEP AWAY**. If you select **AWAY**, you arm all areas of the system. You'll want to arm all areas when leaving with nobody staying inside. Selecting **HOME** arms only the Perimeter of the system. Perimeter arming is for when you're staying inside but want the comfort of knowing the exterior doors and windows are armed. Perimeter arming allows you to move freely about inside without setting off any interior alarms.

Selecting **SLEEP** arms the Perimeter and Interior devices but leaves devices near bedrooms or other nighttime areas off.

System Ready/System Not Ready Keypad Displays

When all zones in the system are in a normal condition and can be armed without bypassing, the keypad displays **SYSTEM READY**. If there are one or more zones that are not in a normal condition, the keypad displays **SYSTEM NOT READY**. Pressing any top row SELECT key during this display shows the zone number and name allowing you to investigate the problem.

Arming a Home/Away System

1. Enter a 2 to 3 digit code and press the COMMAND key or enter a 4 digit code without pressing the COMMAND key. The keypad displays **HOME AWAY** or **HOME SLEEP AWAY** (your system may have two or three areas).
2. Select **HOME** to arm the Perimeter only.

3. Select **SLEEP** to arm the Perimeter and Interior.
4. Select **AWAY** to arm the Perimeter, Interior, and Bedroom.
5. The system displays any Bypassed zones or bad 24 hour or Priority zones. A bad Priority zone cannot be armed.
6. At this point you can **force arm** or **bypass** any bad zones. A zone that is force armed will be restored into the system if it later returns to normal. A zone that is bypassed will remain bypassed until the system is disarmed. See steps 6a through 6d.
 - 6a. If a problem exists on a zone, the zone name and problem is shown followed by **OKAY BYPASS STOP**.
 - 6b. Select **OKAY** to force arm the zone(s) before arming.
 - 6c. Select **BYPASS** to bypass the zone(s) before arming.
 - 6d. Select **STOP** to stop the system from arming. Correct the zone problem(s) and return to step 1.
7. The keypad displays **PERIMETER ON** if you selected **HOME**, **PERIM/INT ON** if you selected **SLEEP**, and **ALL SYSTEM ON** if you selected **AWAY**.
8. The keypad next displays **EXIT: ## INSTNT** and begins to count down the number of seconds remaining for you to exit. When the delay expires, the exit zones are armed.
9. You can select **INSTNT** while **EXIT: ## INSTNT** is displayed to immediately arm all exit zones and make them instant. The keypad displays **INSTANT**.

Arming and Disarming 11

3. Select **SLEEP** to arm the Perimeter and Interior.
4. Select **AWAY** to arm the Perimeter, Interior, and Bedroom.
5. The system displays any Bypassed zones or bad 24 hour or Priority zones. A bad Priority zone cannot be armed.
6. At this point you can **force arm** or **bypass** any bad zones. A zone that is force armed will be restored into the system if it later returns to normal. A zone that is bypassed will remain bypassed until the system is disarmed. See steps 6a through 6d.
 - 6a. If a problem exists on a zone, the zone name and problem is shown followed by **OKAY BYPASS STOP**.
 - 6b. Select **OKAY** to force arm the zone(s) before arming.
 - 6c. Select **BYPASS** to bypass the zone(s) before arming.
 - 6d. Select **STOP** to stop the system from arming. Correct the zone problem(s) and return to step 1.
7. The keypad displays **PERIMETER ON** if you selected **HOME**, **PERIM/INT ON** if you selected **SLEEP**, and **ALL SYSTEM ON** if you selected **AWAY**.
8. The keypad next displays **EXIT: ## INSTNT** and begins to count down the number of seconds remaining for you to exit. When the delay expires, the exit zones are armed.
9. You can select **INSTNT** while **EXIT: ## INSTNT** is displayed to immediately arm all exit zones and make them instant. The keypad displays **INSTANT**.

Arming and Disarming 11

Home/Away System Disarming

Disarming: While the system is armed, you can only enter the premises through an entry/exit delay door without causing an alarm. After opening the door, the Security Command keypad sounds a prewarn tone to remind you to disarm the system. You must disarm the system before the prewarn tone expires or an alarm on the door zone will occur.

During the prewarn tone, the keypad displays **ENTER CODE:.** Enter your code to disarm the system.

Schedules: If you've programmed schedules for your system and a level 2 code is entered outside of a schedule, the keypad displays **INVALID TIME.** This lets the user know that they are disarming outside of their authorized time. If your system is monitored, an Unauthorized Entry report is sent to the central station.

Alarm Display: After disarming, the keypad displays any zones that tripped or any transmission problems that occurred during the armed period. All burglary zones are then disarmed and any bypassed zones are automatically reset.

Disarmed Message: The keypad displays **ALL SYSTEM OFF** after the system disarms.

Central Station Report: A report of the system disarming can be transmitted to the central station. This is optional and can be programmed for you at any time.

Disarming a Home/Away System

1. During the entry delay, the keypad displays **ENTER CODE:.** Enter a 2 to 3 digit user code and press **COMMAND** or enter a 4 digit code without pressing **COMMAND**.
2. The keypad then displays any alarms or communication problems that occurred during the armed period.
3. The keypad next displays **ALL SYSTEM OFF** to confirm the system is disarmed.

Disarming During an Alarm

1. While the alarm bell or siren is sounding, enter a 2 to 3 digit user code and press **COMMAND** or enter a 4 digit user code. The keypad displays **DISARM SILENCE.**
2. Press the **SELECT** key under **DISARM** to disarm the system and silence the alarm.

The keypad next displays **ALL SYSTEM OFF** to confirm the system is disarmed.

3. Press the **SELECT** key under **SILENCE** to stop the bell or siren but **NOT** disarm the system.

If you do not press any **SELECT** key, or you press the **COMMAND** key, the system will automatically disarm and silence the alarm.

4. If your system is programmed to send an Abort (alarm cancel) report to the central station, the keypad displays **ALARM CANCELLED.**

12 Arming and Disarming

Home/Away System Disarming

Disarming: While the system is armed, you can only enter the premises through an entry/exit delay door without causing an alarm. After opening the door, the Security Command keypad sounds a prewarn tone to remind you to disarm the system. You must disarm the system before the prewarn tone expires or an alarm on the door zone will occur.

During the prewarn tone, the keypad displays **ENTER CODE:.** Enter your code to disarm the system.

Schedules: If you've programmed schedules for your system and a level 2 code is entered outside of a schedule, the keypad displays **INVALID TIME.** This lets the user know that they are disarming outside of their authorized time. If your system is monitored, an Unauthorized Entry report is sent to the central station.

Alarm Display: After disarming, the keypad displays any zones that tripped or any transmission problems that occurred during the armed period. All burglary zones are then disarmed and any bypassed zones are automatically reset.

Disarmed Message: The keypad displays **ALL SYSTEM OFF** after the system disarms.

Central Station Report: A report of the system disarming can be transmitted to the central station. This is optional and can be programmed for you at any time.

Disarming a Home/Away System

1. During the entry delay, the keypad displays **ENTER CODE:.** Enter a 2 to 3 digit user code and press **COMMAND** or enter a 4 digit code without pressing **COMMAND**.
2. The keypad then displays any alarms or communication problems that occurred during the armed period.
3. The keypad next displays **ALL SYSTEM OFF** to confirm the system is disarmed.

Disarming During an Alarm

1. While the alarm bell or siren is sounding, enter a 2 to 3 digit user code and press **COMMAND** or enter a 4 digit user code. The keypad displays **DISARM SILENCE.**
2. Press the **SELECT** key under **DISARM** to disarm the system and silence the alarm.

The keypad next displays **ALL SYSTEM OFF** to confirm the system is disarmed.

3. Press the **SELECT** key under **SILENCE** to stop the bell or siren but **NOT** disarm the system.

If you do not press any **SELECT** key, or you press the **COMMAND** key, the system will automatically disarm and silence the alarm.

4. If your system is programmed to send an Abort (alarm cancel) report to the central station, the keypad displays **ALARM CANCELLED.**

12 Arming and Disarming

User Menu

Security Command User Menu

Many of the features of your system have been put into a User Menu that you can access from any Security Command keypad. The menu requires you to enter your user code and then only shows those functions to which you have access.

To access the User Menu:

1. Press the COMMAND key until **MENU? NO YES** displays.
2. Select **YES**. The keypad displays **ENTER CODE: -**. Enter your user code and press COMMAND. You can now scroll down through the list of system features available to your authority level.

User Menu Options

The list below shows the User Menu options in order:

Menu Option	Description
ALARM SILENCE	Silences an alarm bell or siren.
SENSOR RESET	Resets smoke or glassbreak detectors that have latched due to an alarm condition.
DOOR ACCESS	Opens the keypad door lock relay momentarily.
ARMED AREAS	Displays the name of any areas in the system that are currently in the armed state.
OUTPUTS ON/OFF	Allows you to turn on or off any of the outputs described in the System Setup section of this guide.

ZONE STATUS	Allows you to enter a zone number and see if that zone is either armed, bypassed, in alarm, open, or shorted.
BYPASS ZONES	Allows you to Bypass a zone or reset an already bypassed zone.
ZONE MONITOR	Allows you to add or remove a zone from the monitor mode.
SYSTEM STATUS	Displays the current condition of the system's AC power, backup battery, and panel tamper (optional).
SYSTEM TEST	Tests the system's siren, communication to the central station, and backup battery.
USER CODES	Allows you to add, delete, or change user codes and authority levels.
SCHEDULES	Allows you to add, remove, or change system schedules.
TIME	Allows you change the Day, Date, or Time that is currently in the system.
DISPLAY EVENTS	Allows you to view or print the last 200 events that occurred on your system.
SERVICE REQUEST	Allows you to send a message to the Central Station requesting service on the alarm system.

The following pages detail each user menu item and provide instructions on when and how to use them properly.

User Menu 13

User Menu

Security Command User Menu

Many of the features of your system have been put into a User Menu that you can access from any Security Command keypad. The menu requires you to enter your user code and then only shows those functions to which you have access.

To access the User Menu:

1. Press the COMMAND key until **MENU? NO YES** displays.
2. Select **YES**. The keypad displays **ENTER CODE: -**. Enter your user code and press COMMAND. You can now scroll down through the list of system features available to your authority level.

User Menu Options

The list below shows the User Menu options in order:

Menu Option	Description
ALARM SILENCE	Silences an alarm bell or siren.
SENSOR RESET	Resets smoke or glassbreak detectors that have latched due to an alarm condition.
DOOR ACCESS	Opens the keypad door lock relay momentarily.
ARMED AREAS	Displays the name of any areas in the system that are currently in the armed state.
OUTPUTS ON/OFF	Allows you to turn on or off any of the outputs described in the System Setup section of this guide.

ZONE STATUS	Allows you to enter a zone number and see if that zone is either armed, bypassed, in alarm, open, or shorted.
BYPASS ZONES	Allows you to Bypass a zone or reset an already bypassed zone.
ZONE MONITOR	Allows you to add or remove a zone from the monitor mode.
SYSTEM STATUS	Displays the current condition of the system's AC power, backup battery, and panel tamper (optional).
SYSTEM TEST	Tests the system's siren, communication to the central station, and backup battery.
USER CODES	Allows you to add, delete, or change user codes and authority levels.
SCHEDULES	Allows you to add, remove, or change system schedules.
TIME	Allows you change the Day, Date, or Time that is currently in the system.
DISPLAY EVENTS	Allows you to view or print the last 200 events that occurred on your system.
SERVICE REQUEST	Allows you to send a message to the Central Station requesting service on the alarm system.

The following pages detail each user menu item and provide instructions on when and how to use them properly.

User Menu 13

Alarm Silence

User Code Level: 2 and above.

Function: Silences the alarm bell or siren during an alarm.

Alarm Silence allows you to turn off the alarm bell or siren connected to your system during an alarm. Using Alarm Silence does NOT stop an alarm report from being sent to the central station and does not reset any alarmed devices. Use the Sensor Reset function to reset devices such as smoke detectors that have latched in alarm.

Note: You can also silence an alarm by entering your user code and pressing COMMAND while the bell or siren is still sounding.

Using the Alarm Silence Function

1. Access the User Menu.
2. The keypad displays **ALARM SILENCE?**.
3. Press any SELECT key. The system silences the bell or siren and exits the User Menu.

Sensor Reset

User Code Level: 1 and 2 - During schedules only. 3 to 9 - Anytime.

Function: Resets smoke or glassbreak detectors. Also clears Fire/Supervisory alarm and trouble displays.

Sensor Reset is used to reset smoke and glassbreak detectors after they have been tripped. Once these detectors have tripped, they must be reset before they can detect any additional alarm conditions. When Sensor Reset is selected, power to the detectors is temporarily removed by the system allowing them to reset.

Make sure all smoke is cleared from around the area of the smoke detectors before performing a Sensor Reset to prevent the alarm from occurring again.

Resetting the Sensors

1. Access the User Menu.
2. Press COMMAND until **SENSOR RESET** displays.
3. The keypad displays **SENSORS OFF** for five seconds followed by **SENSORS ON**.
4. The keypad automatically exits the User Menu.

14 User Menu

Alarm Silence

User Code Level: 2 and above.

Function: Silences the alarm bell or siren during an alarm.

Alarm Silence allows you to turn off the alarm bell or siren connected to your system during an alarm. Using Alarm Silence does NOT stop an alarm report from being sent to the central station and does not reset any alarmed devices. Use the Sensor Reset function to reset devices such as smoke detectors that have latched in alarm.

Note: You can also silence an alarm by entering your user code and pressing COMMAND while the bell or siren is still sounding.

Using the Alarm Silence Function

1. Access the User Menu.
2. The keypad displays **ALARM SILENCE?**.
3. Press any SELECT key. The system silences the bell or siren and exits the User Menu.

Sensor Reset

User Code Level: 1 and 2 - During schedules only. 3 to 9 - Anytime.

Function: Resets smoke or glassbreak detectors. Also clears Fire/Supervisory alarm and trouble displays.

Sensor Reset is used to reset smoke and glassbreak detectors after they have been tripped. Once these detectors have tripped, they must be reset before they can detect any additional alarm conditions. When Sensor Reset is selected, power to the detectors is temporarily removed by the system allowing them to reset.

Make sure all smoke is cleared from around the area of the smoke detectors before performing a Sensor Reset to prevent the alarm from occurring again.

Resetting the Sensors

1. Access the User Menu.
2. Press COMMAND until **SENSOR RESET** displays.
3. The keypad displays **SENSORS OFF** for five seconds followed by **SENSORS ON**.
4. The keypad automatically exits the User Menu.

14 User Menu

Door Access

User Code Level: 1 and 2 - During schedules only. 3 to 9 - Anytime.

Function: Operates an electric door strike from the keypad.

Door Access is used to operate a door strike relay that is built into some Security Command keypads. Power for the door strike is connected to the keypad relay and can be interrupted by using the Door Access function.

When Door Access is selected you'll be asked to enter your user code. When the user code is accepted, the door strike at the Security Command you're operating turns on momentarily.

Door Access also functions any time any area of the system is disarmed at the door strike keypad or by simply entering your user code and pressing COMMAND.

A report of this entry can be transmitted to your central station. This report is optional and can be programmed for you at any time.

Using the Door Access

1. Access the User Menu.
2. Press COMMAND until **DOOR ACCESS?** displays.
3. Press any SELECT key. The door strike relay turns on momentarily.
4. The keypad returns to the Status List display.

Door Access

User Code Level: 1 and 2 - During schedules only. 3 to 9 - Anytime.

Function: Operates an electric door strike from the keypad.

Door Access is used to operate a door strike relay that is built into some Security Command keypads. Power for the door strike is connected to the keypad relay and can be interrupted by using the Door Access function.

When Door Access is selected you'll be asked to enter your user code. When the user code is accepted, the door strike at the Security Command you're operating turns on momentarily.

Door Access also functions any time any area of the system is disarmed at the door strike keypad or by simply entering your user code and pressing COMMAND.

A report of this entry can be transmitted to your central station. This report is optional and can be programmed for you at any time.

Using the Door Access

1. Access the User Menu.
2. Press COMMAND until **DOOR ACCESS?** displays.
3. Press any SELECT key. The door strike relay turns on momentarily.
4. The keypad returns to the Status List display.

Armed Areas Display

User Code Level: 1 and 2 - During schedules only. 3 to 9 - Anytime.

Function: Displays all armed areas in the system.

Armed Areas is used to display all of the armed areas in your system at the Security Command keypads. Each armed area is displayed along with its area number and name.

Using the Armed Areas Function

1. Access the User Menu.
2. Press COMMAND until **ARMED AREAS?** displays.
3. Press any SELECT key. The keypad displays the first armed area name. To scroll through the list of armed areas, press the COMMAND key.
All/Perimeter and Home/Away systems: Armed areas for these systems are shown as **PERIMETER**, **INTERIOR**, and also **BEDROOMS** for Home/Away systems.
4. If there are no armed areas, the keypad displays **NONE**.

User Menu 15

Armed Areas Display

User Code Level: 1 and 2 - During schedules only. 3 to 9 - Anytime.

Function: Displays all armed areas in the system.

Armed Areas is used to display all of the armed areas in your system at the Security Command keypads. Each armed area is displayed along with its area number and name.

Using the Armed Areas Function

1. Access the User Menu.
2. Press COMMAND until **ARMED AREAS?** displays.
3. Press any SELECT key. The keypad displays the first armed area name. To scroll through the list of armed areas, press the COMMAND key.
All/Perimeter and Home/Away systems: Armed areas for these systems are shown as **PERIMETER**, **INTERIOR**, and also **BEDROOMS** for Home/Away systems.
4. If there are no armed areas, the keypad displays **NONE**.

User Menu 15

Outputs On Off

User Code Level: 5 and above.

Function: Allows you to turn the system relay outputs on and off.

This function is used to individually turn your system's relay outputs on and off. Your system may use these outputs to control interior and exterior lighting, heating, air conditioning, or other appliances.

The names and numbers of the relays connected to your system are located in the System Setup section of this guide.

Turning the Outputs On and Off

1. Access the User Menu.
2. Press COMMAND until **OUTPUTS ON/OFF?** displays.
3. Press any SELECT key to display **OUTPUT: - ON OFF**.
4. Enter the output number you want to turn on or off. The output number will appear in the display.
5. With the output number displayed, press the SELECT key under **ON** or **OFF**. The output is then turned on or off, depending on your selection, and remains in that state until you change it.

Under certain conditions, some outputs cannot be turned on. If you select a restricted output, the keypad displays **CANNOT TURN ON**.

6. The system automatically removes the output number and a new output number can be entered. Refer back to step 4.

Press the ARROW key to exit the User Menu.

16 User Menu

Outputs On Off

User Code Level: 5 and above.

Function: Allows you to turn the system relay outputs on and off.

This function is used to individually turn your system's relay outputs on and off. Your system may use these outputs to control interior and exterior lighting, heating, air conditioning, or other appliances.

The names and numbers of the relays connected to your system are located in the System Setup section of this guide.

Turning the Outputs On and Off

1. Access the User Menu.
2. Press COMMAND until **OUTPUTS ON/OFF?** displays.
3. Press any SELECT key to display **OUTPUT: - ON OFF**.
4. Enter the output number you want to turn on or off. The output number will appear in the display.
5. With the output number displayed, press the SELECT key under **ON** or **OFF**. The output is then turned on or off, depending on your selection, and remains in that state until you change it.

Under certain conditions, some outputs cannot be turned on. If you select a restricted output, the keypad displays **CANNOT TURN ON**.

6. The system automatically removes the output number and a new output number can be entered. Refer back to step 4.

Press the ARROW key to exit the User Menu.

16 User Menu

Zone Status

User Code Level: All users at any time.

Function: Displays a list of armed, bypassed, or alarmed zones. Also allows you to check the status of individual zones.

Zone Status can be used to give you a list of zones by category or display the current status of an individual zone number. The four categories are:

- **Armed Zones** - zones that are currently armed.
- **Bypassed Zones** - zones that are currently bypassed.
- **Alarmed Zones** - zones that have gone into alarm during the current or previous armed period.
- **Number** - enter the number of any zone to check its status.

Using the Zone Status Function

1. Access the User Menu.
2. Press COMMAND until **ZONE STATUS?** is displayed.
3. Press any SELECT key to display **ARM BYPS ALR NBR**.
4. Select **ARM** for a list of zones that are currently armed. You can scroll through the list by pressing the COMMAND key.
5. Select **BYPS** for a list of zones that are currently bypassed.
6. Select **ALR** for a list of zones that have gone into alarm during the current or previous armed period.
7. Press **NBR** and **ZONE NO: -** will be displayed.

Zone Status

User Code Level: All users at any time.

Function: Displays a list of armed, bypassed, or alarmed zones. Also allows you to check the status of individual zones.

Zone Status can be used to give you a list of zones by category or display the current status of an individual zone number. The four categories are:

- **Armed Zones** - zones that are currently armed.
- **Bypassed Zones** - zones that are currently bypassed.
- **Alarmed Zones** - zones that have gone into alarm during the current or previous armed period.
- **Number** - enter the number of any zone to check its status.

Using the Zone Status Function

1. Access the User Menu.
2. Press COMMAND until **ZONE STATUS?** is displayed.
3. Press any SELECT key to display **ARM BYPS ALR NBR**.
4. Select **ARM** for a list of zones that are currently armed. You can scroll through the list by pressing the COMMAND key.
5. Select **BYPS** for a list of zones that are currently bypassed.
6. Select **ALR** for a list of zones that have gone into alarm during the current or previous armed period.
7. Press **NBR** and **ZONE NO: -** will be displayed.

Zone Status continued

- At the **ZONE NO:** - prompt, enter the zone number you want to check and press COMMAND. The zone number and name is displayed followed by its status. For example, a zone status for zone 1 might be: **BACK DOOR - OKAY**.

Below is a list of the zone status displays:

- OKAY** = the zone is in a normal condition
- BYPAS** = the zone is bypassed
- BAD** = the zone is in a bad condition

- After displaying the zone status, **ZONE:** - returns for you to enter another zone number.

Browser Feature

If you're unsure of the zone number or description, refer to the Appendix at the back of this guide for a diagram showing you how to use the built-in **Zone Status browser**.

Zone Status continued

- At the **ZONE NO:** - prompt, enter the zone number you want to check and press COMMAND. The zone number and name is displayed followed by its status. For example, a zone status for zone 1 might be: **BACK DOOR - OKAY**.

Below is a list of the zone status displays:

- OKAY** = the zone is in a normal condition
- BYPAS** = the zone is bypassed
- BAD** = the zone is in a bad condition

- After displaying the zone status, **ZONE:** - returns for you to enter another zone number.

Browser Feature

If you're unsure of the zone number or description, refer to the Appendix at the back of this guide for a diagram showing you how to use the built-in **Zone Status browser**.

Bypass Zones

User Code Level: 6 and above.

Function: Allows you to bypass a zone prior to arming.

Bypassing is usually done when a zone cannot be restored to normal. A zone can be bypassed only while it's disarmed. Since fire, panic, emergency, and supervisory type zones are always armed, they can never be bypassed.

Bypass Zones can also be used to reset a zone that has been bypassed and restore it back into the system. This can only be done while the zone is disarmed.

When Bypass Zones is selected, a report can be transmitted to your central station.

Using the Bypass Zones Function

- Access the User Menu.
- Press COMMAND until **BYPASS ZONES?** displays.
- Press any SELECT key. The keypad displays **ZONE: - RST BYPS**.
- To Bypass a zone, enter the zone number and select **BYPS**. The zone number automatically disappears and a new zone number can be entered. Refer back to step 3.
- To Reset a zone, enter the zone number and select **RST**.

Browser Feature

If you're unsure of the zone number or description, refer to the Appendix at the back of this guide for a diagram showing you how to use the built-in **Bypass Zones browser**.

User Menu 17

Bypass Zones

User Code Level: 6 and above.

Function: Allows you to bypass a zone prior to arming.

Bypassing is usually done when a zone cannot be restored to normal. A zone can be bypassed only while it's disarmed. Since fire, panic, emergency, and supervisory type zones are always armed, they can never be bypassed.

Bypass Zones can also be used to reset a zone that has been bypassed and restore it back into the system. This can only be done while the zone is disarmed.

When Bypass Zones is selected, a report can be transmitted to your central station.

Using the Bypass Zones Function

- Access the User Menu.
- Press COMMAND until **BYPASS ZONES?** displays.
- Press any SELECT key. The keypad displays **ZONE: - RST BYPS**.
- To Bypass a zone, enter the zone number and select **BYPS**. The zone number automatically disappears and a new zone number can be entered. Refer back to step 3.
- To Reset a zone, enter the zone number and select **RST**.

Browser Feature

If you're unsure of the zone number or description, refer to the Appendix at the back of this guide for a diagram showing you how to use the built-in **Bypass Zones browser**.

User Menu 17

Zone Monitor

User Code Level: 4 and above.

Function: Allows the system to monitor selected disarmed zones (doors, windows, or motion detectors) and display their name at the keypad as they're faulted.

Zone Monitor works with any disarmed zone and will also sound the keypad monitor tone when the zone faults. The zone name is displayed at all keypads in your system.

You can place any combination of disarmed zones in Zone Monitor but only the most recent zone faulted is displayed. The displayed zone name clears automatically after a short time or when the zone is armed.

Using Zone Monitor as part of your weekly system test: After using the System Test function (see page 19), place all perimeter and interior zones in Zone Monitor. Starting at the front door, go around and open and then close each door and window. You should hear the keypad beep each time. The keypad will also display the name of each zone as its device is opened.

Once all protected doors and windows have been tested, walk in front of each motion detector. The keypad should beep to confirm their operation. If at any time during your weekly testing a device does not cause the keypad to beep, call the service department for assistance.

Using the Zone Monitor Function

1. Access the User Menu.
2. Press COMMAND until **ZONE MONITOR?** displays.

18 User Menu

Zone Monitor

User Code Level: 4 and above.

Function: Allows the system to monitor selected disarmed zones (doors, windows, or motion detectors) and display their name at the keypad as they're faulted.

Zone Monitor works with any disarmed zone and will also sound the keypad monitor tone when the zone faults. The zone name is displayed at all keypads in your system.

You can place any combination of disarmed zones in Zone Monitor but only the most recent zone faulted is displayed. The displayed zone name clears automatically after a short time or when the zone is armed.

Using Zone Monitor as part of your weekly system test: After using the System Test function (see page 19), place all perimeter and interior zones in Zone Monitor. Starting at the front door, go around and open and then close each door and window. You should hear the keypad beep each time. The keypad will also display the name of each zone as its device is opened.

Once all protected doors and windows have been tested, walk in front of each motion detector. The keypad should beep to confirm their operation. If at any time during your weekly testing a device does not cause the keypad to beep, call the service department for assistance.

Using the Zone Monitor Function

1. Access the User Menu.
2. Press COMMAND until **ZONE MONITOR?** displays.

18 User Menu

3. Press any SELECT key. The keypad displays **ALL NBR** for an Area system (skip ahead to number 5) and **PERIM ALL NBR** for an All/Perimeter or Home/Away system.
4. Select **PERIM** to place all disarmed perimeter zones into Zone Monitor. **PERIM** is displayed only on All/Perimeter and Home/Away systems.
 - 4a. The keypad displays **PERIM? ADD RMV**.
 - 4b. Select **ADD** to put all perimeter zones into Zone Monitor.
 - 4c. Select **RMV** to remove all perimeter zones.
5. Select **ALL** to place all disarmed zones into Zone Monitor.
 - 5a. The keypad displays **ALL? ADD RMV**.
 - 5b. Select **ADD** to add all disarmed zones to Zone Monitor.
 - 5c. Select **RMV** to remove all disarmed zones.
6. Select **NBR** to enter a specific zone number for zone monitor.
7. If **NBR** is selected, the keypad displays **ZONE: - ADD RMV**.
 - 7a. Enter any zone number and select **ADD** to add this zone.
 - 7b. Enter any zone number and select **RMV** to remove this zone.
8. The zone number automatically disappears and a new zone number can then be entered in step 7a or 7b.

Browser Feature

If you're unsure of the zone number or description, refer to the Appendix at the back of this guide for a diagram showing you how to use the built-in **Zone Monitor browser**.

3. Press any SELECT key. The keypad displays **ALL NBR** for an Area system (skip ahead to number 5) and **PERIM ALL NBR** for an All/Perimeter or Home/Away system.
4. Select **PERIM** to place all disarmed perimeter zones into Zone Monitor. **PERIM** is displayed only on All/Perimeter and Home/Away systems.
 - 4a. The keypad displays **PERIM? ADD RMV**.
 - 4b. Select **ADD** to put all perimeter zones into Zone Monitor.
 - 4c. Select **RMV** to remove all perimeter zones.
5. Select **ALL** to place all disarmed zones into Zone Monitor.
 - 5a. The keypad displays **ALL? ADD RMV**.
 - 5b. Select **ADD** to add all disarmed zones to Zone Monitor.
 - 5c. Select **RMV** to remove all disarmed zones.
6. Select **NBR** to enter a specific zone number for zone monitor.
7. If **NBR** is selected, the keypad displays **ZONE: - ADD RMV**.
 - 7a. Enter any zone number and select **ADD** to add this zone.
 - 7b. Enter any zone number and select **RMV** to remove this zone.
8. The zone number automatically disappears and a new zone number can then be entered in step 7a or 7b.

Browser Feature

If you're unsure of the zone number or description, refer to the Appendix at the back of this guide for a diagram showing you how to use the built-in **Zone Monitor browser**.

System Status

User Code Level: 1 and 2 - During schedules only. 3 to 9 - Anytime.

Function: Displays the current condition of internal system hardware.

System Status displays the condition of the panel's AC power, battery power, and optional panel tamper. When System Status is selected, each monitor is displayed followed by **OKAY** or **TRBL** (Trouble) to indicate the current condition.

Using the System Status Function

1. Access the User Menu.
2. Press COMMAND until **SYSTEM STATUS?** displays.
3. Press any SELECT key. The display starts listing each system monitor and status.

For example: **AC POWER - OKAY**

Below are the System Monitor displays:

Keypad Display	What it monitors
AC POWER	= AC power
BATTERY	= Battery power
TAMPER	= Panel box tamper

These are followed by either **OKAY** or **TRBL** (trouble).

If **TRBL** is displayed, call the service department for assistance.

4. The system then displays its firmware version (for example, **VER_102_10/17/97**), the panel model (**MODEL XR200**), then exits the User Menu.

System Status

User Code Level: 1 and 2 - During schedules only. 3 to 9 - Anytime.

Function: Displays the current condition of internal system hardware.

System Status displays the condition of the panel's AC power, battery power, and optional panel tamper. When System Status is selected, each monitor is displayed followed by **OKAY** or **TRBL** (Trouble) to indicate the current condition.

Using the System Status Function

1. Access the User Menu.
2. Press COMMAND until **SYSTEM STATUS?** displays.
3. Press any SELECT key. The display starts listing each system monitor and status.

For example: **AC POWER - OKAY**

Below are the System Monitor displays:

Keypad Display	What it monitors
AC POWER	= AC power
BATTERY	= Battery power
TAMPER	= Panel box tamper

These are followed by either **OKAY** or **TRBL** (trouble).

If **TRBL** is displayed, call the service department for assistance.

4. The system then displays its firmware version (for example, **VER_102_10/17/97**), the panel model (**MODEL XR200**), then exits the User Menu.

System Test

User Code Level: 4 and above.

Function: System Test is used to test the battery, alarm bell or siren, and communication to a central station. The System Test function begins automatically as soon as you select it.

Using the System Test Function

1. Access the User Menu.
2. Press COMMAND until **SYSTEM TEST?** displays.
3. Press any SELECT key. The system test begins automatically and the keypad displays:
 - 1) **BELL SOUNDING** during a two second bell test, then:
 - 2) **BATTERY - OKAY** or **BATTERY - TRBL** to indicate the condition of the battery, then:

* 3) **TRANSMIT TEST** and **ATTEMPT NO : 1** during the transmit test, then:

4) **TRANSMIT OKAY** or **TRANSMIT FAILED** to show the results of the transmit test, then:

5) **TEST END** to indicate the System Test is complete.

6) You can end the transmit test by pressing the ARROW key.

* The transmit test does not operate on local systems.

Testing your system's burglary protection: The System Test function should be a part of your weekly testing and should be followed by placing the interior and perimeter burglary devices in Zone Monitor mode. This allows you to open and then close each protected door and window while listening for the keypad to beep confirming its operation. See Zone Monitor.

User Menu 19

System Test

User Code Level: 4 and above.

Function: System Test is used to test the battery, alarm bell or siren, and communication to a central station. The System Test function begins automatically as soon as you select it.

Using the System Test Function

1. Access the User Menu.
2. Press COMMAND until **SYSTEM TEST?** displays.
3. Press any SELECT key. The system test begins automatically and the keypad displays:
 - 1) **BELL SOUNDING** during a two second bell test, then:
 - 2) **BATTERY - OKAY** or **BATTERY - TRBL** to indicate the condition of the battery, then:

* 3) **TRANSMIT TEST** and **ATTEMPT NO : 1** during the transmit test, then:

4) **TRANSMIT OKAY** or **TRANSMIT FAILED** to show the results of the transmit test, then:

5) **TEST END** to indicate the System Test is complete.

6) You can end the transmit test by pressing the ARROW key.

* The transmit test does not operate on local systems.

Testing your system's burglary protection: The System Test function should be a part of your weekly testing and should be followed by placing the interior and perimeter burglary devices in Zone Monitor mode. This allows you to open and then close each protected door and window while listening for the keypad to beep confirming its operation. See Zone Monitor.

User Menu 19

User Codes

User Code Level: 9 only.

Function: Allows you to add, delete, and change a user's (person operating the system) user code or authority level.

There are three characteristics associated with each user code that define its capabilities within the system.

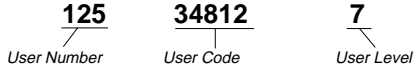

User Number - Every user is numbered. This number identifies them to the system and can be transmitted to the central station when they arm or disarm areas.

User Code - Each user also has a 3 to 5 digit number they enter into the Security Command keypad when arming or disarming the system. NOTE: A User Code cannot begin or end with zero or be in the range of 1 to 299.

User Names - Each code may also be programmed with the user's name. Up to 16 characters may be entered.

Areas - Each user may be assigned specific areas in the burglary alarm system.

User Level - The user is also assigned a level of authority (1 to 9) or customized authority by the person administrating the system that determines the functions the user can access.

Important: Each area must have at least one user with a level 9 authority in order to be able to add or delete user codes.

The following table lists system functions users are allowed to access based on the authority level assigned to their codes.

User Code Authority Levels

Menu Options	1	2	3	4	5	6	7	8	9
Sensor Reset	*	*	√	√	√	√	√	√	√
Armed Areas	*	*	√	√	√	√	√	√	√
Zone Status	*	*	√	√	√	√	√	√	√
System Status	*	*	√	√	√	√	√	√	√
Display Events	*	*	√	√	√	√	√	√	√
Door Access	*	*	√	√	√	√	√	√	√
Arm and Disarm		+	√	√	√	√	√	√	√
Alarm Silence		*	√	√	√	√	√	√	√
System Test				√	√	√	√	√	√
Zone Monitor				√	√	√	√	√	√
Outputs On/Off					√	√	√	√	√
Extend						√	√	√	√
Bypass Zones						√	√	√	√
Schedules							√	√	√
Set Time								√	√
User Codes									√

* = These functions can only be accessed during certain schedules.
 + = Arming allowed anytime. Disarming allowed outside of a schedule but an Unauthorized Entry report is sent to the central station.

20 User Menu

User Codes

User Code Level: 9 only.

Function: Allows you to add, delete, and change a user's (person operating the system) user code or authority level.

There are three characteristics associated with each user code that define its capabilities within the system.

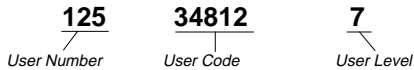

User Number - Every user is numbered. This number identifies them to the system and can be transmitted to the central station when they arm or disarm areas.

User Code - Each user also has a 3 to 5 digit number they enter into the Security Command keypad when arming or disarming the system. NOTE: A User Code cannot begin or end with zero or be in the range of 1 to 299.

User Names - Each code may also be programmed with the user's name. Up to 16 characters may be entered.

Areas - Each user may be assigned specific areas in the burglary alarm system.

User Level - The user is also assigned a level of authority (1 to 9) or customized authority by the person administrating the system that determines the functions the user can access.

Important: Each area must have at least one user with a level 9 authority in order to be able to add or delete user codes.

The following table lists system functions users are allowed to access based on the authority level assigned to their codes.

User Code Authority Levels

Menu Options	1	2	3	4	5	6	7	8	9
Sensor Reset	*	*	√	√	√	√	√	√	√
Armed Areas	*	*	√	√	√	√	√	√	√
Zone Status	*	*	√	√	√	√	√	√	√
System Status	*	*	√	√	√	√	√	√	√
Display Events	*	*	√	√	√	√	√	√	√
Door Access	*	*	√	√	√	√	√	√	√
Arm and Disarm		+	√	√	√	√	√	√	√
Alarm Silence		*	√	√	√	√	√	√	√
System Test				√	√	√	√	√	√
Zone Monitor				√	√	√	√	√	√
Outputs On/Off					√	√	√	√	√
Extend						√	√	√	√
Bypass Zones						√	√	√	√
Schedules							√	√	√
Set Time								√	√
User Codes									√

* = These functions can only be accessed during certain schedules.
 + = Arming allowed anytime. Disarming allowed outside of a schedule but an Unauthorized Entry report is sent to the central station.

20 User Menu

User Codes continued

Programming Custom User Codes

In addition to the preset authority levels, you can also create custom authority levels by selecting the **CUSTOM** option at the time the user is being added to the system. This option allows you to assign specific User Menu access to individual users.

Adding User Codes:

1. Access the User Menu.
2. Press COMMAND until **USER CODES?** displays. (**NOTE:** You must have a level 9 authority. If you enter the User Menu with a lower authority, the keypad will not display **USER CODES?**.)
3. Press any SELECT key. The keypad displays **ADD DEL CHG**.
4. Press the SELECT key under **ADD** to add a new user code.
5. At the **USER NUMBER:-** prompt, enter a user number and press COMMAND. The display changes to **CODE NO:-** .
6. Enter a user code of 3 to 5 digits (4 digits on the Home/Away system) and press COMMAND. The user enters this number each time they arm, disarm, or make changes. If using access cards, present the card instead of entering a code. After the code is entered, the display changes to **USER NUMBER ###**.
7. A 16 character name may be entered to identify the user. Press any top row key to clear the current name. You may then enter the new name. After the name is entered, press COMMAND. See Entering Custom Names in the Appendix of this User's Guide.
8. *Areas systems only* - The display changes to **AREAS: # # # #** (# = area number). Add or remove access to one or more areas by pressing the corresponding number keys. Press COMMAND.

Note: You may only add areas that are assigned to your code.

9. The display changes to **LEVEL CUSTOM**. Select **LEVEL** to assign a standard set of authorized functions as outlined in the **User Code Authority Levels** table on the previous page.
10. At the **LEVEL: -** display, enter an authority level from 1 to 9. Press COMMAND. The displays shows **USER # ADDED**.
11. Select **CUSTOM** to customize the functions you want the user to access. This allows users to have certain capabilities outside of a standard authority level. The following chart shows the custom menu with default selections.

ARM/DIS (arm & disarm) NO	SYS STAT (system status) NO
ALM SLNC (alarm silence) NO	SYS TEST (system test) NO
SNSR RST (sensor reset) NO	USR CODE (user codes) NO
DOOR ACS (door access) NO	SCHEDULS (schedules) NO
ARM AREA (armed areas) NO	TIME (day, date, and time) NO
OUTPUTS (outputs on off) NO	DIS EVNT (display events) NO
ZN STATS (zone status) NO	EXTEND (extend closing) NO
BYPAS ZN (bypass zones) NO	* TEMP CODE (temporary code) NO
ZONE MON (zone monitor) NO	

- * • **NO** makes this a permanent user code.
 - **YES** makes this a temporary code that expires in 7 days.
12. Press the ARROW key to exit the User Menu.

Note: Customized codes are not restricted to the schedules.

Browser Feature

Refer to the Appendix at the back of this guide for a diagram showing you how to use the built-in **Add User Codes browser**.

User Menu **21**

User Codes continued

Programming Custom User Codes

In addition to the preset authority levels, you can also create custom authority levels by selecting the **CUSTOM** option at the time the user is being added to the system. This option allows you to assign specific User Menu access to individual users.

Adding User Codes:

1. Access the User Menu.
2. Press COMMAND until **USER CODES?** displays. (**NOTE:** You must have a level 9 authority. If you enter the User Menu with a lower authority, the keypad will not display **USER CODES?**.)
3. Press any SELECT key. The keypad displays **ADD DEL CHG**.
4. Press the SELECT key under **ADD** to add a new user code.
5. At the **USER NUMBER:-** prompt, enter a user number and press COMMAND. The display changes to **CODE NO:-** .
6. Enter a user code of 3 to 5 digits (4 digits on the Home/Away system) and press COMMAND. The user enters this number each time they arm, disarm, or make changes. If using access cards, present the card instead of entering a code. After the code is entered, the display changes to **USER NUMBER ###**.
7. A 16 character name may be entered to identify the user. Press any top row key to clear the current name. You may then enter the new name. After the name is entered, press COMMAND. See Entering Custom Names in the appendix of this User's Guide.
8. *Areas systems only* - The display changes to **AREAS: # # # #** (# = area number). Add or remove access to one or more areas by pressing the corresponding number keys. Press COMMAND.

Note: You may only add areas that are assigned to your code.

9. The display changes to **LEVEL CUSTOM**. Select **LEVEL** to assign a standard set of authorized functions as outlined in the **User Code Authority Levels** table on the previous page.
10. At the **LEVEL: -** display, enter an authority level from 1 to 9. Press COMMAND. The displays shows **USER # ADDED**.
11. Select **CUSTOM** to customize the functions you want the user to access. This allows users to have certain capabilities outside of a standard authority level. The following chart shows the custom menu with default selections.

ARM/DIS (arm & disarm) NO	SYS STAT (system status) NO
ALM SLNC (alarm silence) NO	SYS TEST (system test) NO
SNSR RST (sensor reset) NO	USR CODE (user codes) NO
DOOR ACS (door access) NO	SCHEDULS (schedules) NO
ARM AREA (armed areas) NO	TIME (day, date, and time) NO
OUTPUTS (outputs on off) NO	DIS EVNT (display events) NO
ZN STATS (zone status) NO	EXTEND (extend closing) NO
BYPAS ZN (bypass zones) NO	* TEMP CODE (temporary code) NO
ZONE MON (zone monitor) NO	

- * • **NO** makes this a permanent user code.
 - **YES** makes this a temporary code that expires in 7 days.
12. Press the ARROW key to exit the User Menu.

Note: Customized codes are not restricted to the schedules.

Browser Feature

Refer to the Appendix at the back of this guide for a diagram showing you how to use the built-in **Add User Codes browser**.

User Menu **21**

User Codes continued

Ambush Codes

Your system may be programmed to allow user number 1 to be an Ambush code. This Ambush code functions identically to a standard code with the exception that it sends a silent alarm to the central station. This silent alarm alerts the operator to a duress situation at the premises and prompts the immediate notification of authorities.

Refer to the System Setup section of this guide to see if your system is programmed for Ambush. If so, do NOT program a code for user number 1 unless you intend to use the Ambush function.

Deleting User Codes

1. Access the User Menu.
2. Press COMMAND until **USER CODES?** displays.
3. Press any SELECT key. The keypad displays **ADD DEL CHG**.
4. Press the SELECT key under **DEL** to delete a user code from the system. You must have a user code level of 9 or have a custom user code with that authority to be able to delete a user code.

Important: Each area must have at least one user with a level 9 authority in order to be able to add or delete user codes. Be careful not to delete all level 9 users from an area.

5. At the **USER NUMBER: -** prompt, enter the user number you want to delete and press COMMAND. The display changes to **USER # DELETED**.
6. The display then changes back to **USER NUMBER: -** allowing you to delete another user. Press the ARROW key twice to exit the User Menu.

22 *User Menu*

User Codes continued

Ambush Codes

Your system may be programmed to allow user number 1 to be an Ambush code. This Ambush code functions identically to a standard code with the exception that it sends a silent alarm to the central station. This silent alarm alerts the operator to a duress situation at the premises and prompts the immediate notification of authorities.

Refer to the System Setup section of this guide to see if your system is programmed for Ambush. If so, do NOT program a code for user number 1 unless you intend to use the Ambush function.

Deleting User Codes

1. Access the User Menu.
2. Press COMMAND until **USER CODES?** displays.
3. Press any SELECT key. The keypad displays **ADD DEL CHG**.
4. Press the SELECT key under **DEL** to delete a user code from the system. You must have a user code level of 9 or have a custom user code with that authority to be able to delete a user code.

Important: Each area must have at least one user with a level 9 authority in order to be able to add or delete user codes. Be careful not to delete all level 9 users from an area.

5. At the **USER NUMBER: -** prompt, enter the user number you want to delete and press COMMAND. The display changes to **USER # DELETED**.
6. The display then changes back to **USER NUMBER: -** allowing you to delete another user. Press the ARROW key twice to exit the User Menu.

22 *User Menu*

Changing User Codes

1. Access the User Menu.
 2. Press the COMMAND key until **USER CODES?** displays.
 3. Press any SELECT key. The keypad displays **ADD DEL CHG**.
 4. Press the SELECT key under **CHG** to change a user code.
 5. At the **USER NUMBER: -** prompt, enter the user number to change and press COMMAND.
 6. The display changes to **CODE NO: *******. Press a SELECT key and enter the new user code. Press COMMAND.
- Note:** Changing a user code does not change the user number.
7. The display then shows the current user name. Press any top row key to clear. See the Entering Custom Names section in the Appendix to enter a new name.
 8. *Areas systems only* - The display changes to **AREAS: # # # #** (# = area number). Add or remove access to one or more areas by pressing the corresponding number keys. Press COMMAND.
 9. The display changes to **LEVEL CUSTOM**. Refer to Adding User Codes on the previous page for a description of this prompt.
 10. After entering the authority level, the keypad displays **USER # CHANGED** for five seconds followed by **USER NUMBER: -**. This display allows you to enter another user number to change. Press the ARROW key twice to exit the User Menu.

Browser Feature

Refer to the Appendix at the back of this guide for a diagram showing you how to use the built-in **Delete or Change User Codes browser**.

Changing User Codes

1. Access the User Menu.
 2. Press the COMMAND key until **USER CODES?** displays.
 3. Press any SELECT key. The keypad displays **ADD DEL CHG**.
 4. Press the SELECT key under **CHG** to change a user code.
 5. At the **USER NUMBER: -** prompt, enter the user number to change and press COMMAND.
 6. The display changes to **CODE NO: *******. Press a SELECT key and enter the new user code. Press COMMAND.
- Note:** Changing a user code does not change the user number.
7. The display then shows the current user name. Press any top row key to clear. See the Entering Custom Names section in the Appendix to enter a new name.
 8. *Areas systems only* - The display changes to **AREAS: # # # #** (# = area number). Add or remove access to one or more areas by pressing the corresponding number keys. Press COMMAND.
 9. The display changes to **LEVEL CUSTOM**. Refer to Adding User Codes on the previous page for a description of this prompt.
 10. After entering the authority level, the keypad displays **USER # CHANGED** for five seconds followed by **USER NUMBER: -**. This display allows you to enter another user number to change. Press the ARROW key twice to exit the User Menu.

Browser Feature

Refer to the Appendix at the back of this guide for a diagram showing you how to use the built-in **Delete or Change User Codes browser**.

Schedules

User Code Level: 7 and above.

Function: The Schedules function allows you to enter into the system the times at which you normally turn your burglary protection ON and OFF each day of the week. Depending on your system's programming, the ON time can be used to verify that the burglary protection is armed. Also, the schedule's ON and OFF times can be used to automatically arm or disarm the burglary protection.

Schedules can also be used to restrict access to the system by users with a 1 or 2 authority level assigned to their user codes.

Your system provides you with three different types of schedules:

1. **Permanent (PRM), Primary (PRI), and Secondary (SEC)** schedules occur at the same time until you change or delete them.
2. **Temporary (TEMP)** schedules occur only once and then are cleared when they expire. These are typically used to allow someone off hours access to the premises when used with a level 1 or 2 code.
3. **Output (OUT)** schedules allow you to set the times when relay outputs connected to your system turn on and off automatically.

Setting an Arming and Disarming Schedule

1. Access the User Menu and press COMMAND until **SCHEDULES?** displays. Press any SELECT key.
2. The keypad displays **PRM TMP OUT** (or **PRI SEC OUT**). Press the SELECT key under **PRM** (or **PRI**). This will allow you to enter a schedule that remains in place until you change or delete it.
3. The keypad displays **SUN MON TUE WED**. Press the COMMAND key to display **THU FRI SAT**. Press the SELECT key under the day you want the schedule to begin.

Schedules

User Code Level: 7 and above.

Function: The Schedules function allows you to enter into the system the times at which you normally turn your burglary protection ON and OFF each day of the week. Depending on your system's programming, the ON time can be used to verify that the burglary protection is armed. Also, the schedule's ON and OFF times can be used to automatically arm or disarm the burglary protection.

Schedules can also be used to restrict access to the system by users with a 1 or 2 authority level assigned to their user codes.

Your system provides you with three different types of schedules:

1. **Permanent (PRM), Primary (PRI), and Secondary (SEC)** schedules occur at the same time until you change or delete them.
2. **Temporary (TEMP)** schedules occur only once and then are cleared when they expire. These are typically used to allow someone off hours access to the premises when used with a level 1 or 2 code.
3. **Output (OUT)** schedules allow you to set the times when relay outputs connected to your system turn on and off automatically.

Setting an Arming and Disarming Schedule

1. Access the User Menu and press COMMAND until **SCHEDULES?** displays. Press any SELECT key.
2. The keypad displays **PRM TMP OUT** (or **PRI SEC OUT**). Press the SELECT key under **PRM** (or **PRI**). This will allow you to enter a schedule that remains in place until you change or delete it.
3. The keypad displays **SUN MON TUE WED**. Press the COMMAND key to display **THU FRI SAT**. Press the SELECT key under the day you want the schedule to begin.

Note: After selecting the day of the week for the schedule to begin, the keypad displays any currently programmed Opening and Closing times previously set for that day. This feature allows you to review programmed schedules at any time.

4. If Opening and Closing times are displayed, the keypad then displays **DELETE KEEP**. Press the SELECT key under **DELETE** to enter new times.
5. The keypad then displays **OPENING TIME?** followed by the display **MON - : AM PM**. Enter the new opening time and select **AM** or **PM**.

Enter all schedule times using a 12 hour clock. For example, to enter 6 AM you would enter a 0 + 6 + 0 + 0 and press the SELECT key under **AM**.

The keypad then displays **CLOSING TIME?** followed by the display **MON - : AM PM**. Enter the new closing time and select **AM** or **PM**. Press the SELECT key under the day **MON** (whichever day is displayed) allows you to scroll through the days of the week and create a schedule window that spans multiple days.

Note: You must enter an Opening *and* Closing time or the system will not recognize the schedule.

The new schedule is now part of your system.

6. The keypad goes back to the **SUN MON TUE WED** display allowing you to enter another schedule.
7. To clear a schedule, press **DELETE** and then **AM** when the opening time is requested.

Press the **ARROW** key to exit the User Menu.

User Menu 23

Note: After selecting the day of the week for the schedule to begin, the keypad displays any currently programmed Opening and Closing times previously set for that day. This feature allows you to review programmed schedules at any time.

4. If Opening and Closing times are displayed, the keypad then displays **DELETE KEEP**. Press the SELECT key under **DELETE** to enter new times.
5. The keypad then displays **OPENING TIME?** followed by the display **MON - : AM PM**. Enter the new opening time and select **AM** or **PM**.

Enter all schedule times using a 12 hour clock. For example, to enter 6 AM you would enter a 0 + 6 + 0 + 0 and press the SELECT key under **AM**.

The keypad then displays **CLOSING TIME?** followed by the display **MON - : AM PM**. Enter the new closing time and select **AM** or **PM**. Pressing the SELECT key under the day **MON** (whichever day is displayed) allows you to scroll through the days of the week and create a schedule window that spans multiple days.

Note: You must enter an Opening *and* Closing time or the system will not recognize the schedule.

The new schedule is now part of your system.

6. The keypad goes back to the **SUN MON TUE WED** display allowing you to enter another schedule.
7. To clear a schedule, press **DELETE** and then **AM** when the opening time is requested.

Press the **ARROW** key to exit the User Menu.

User Menu 23

Schedules continued

Area Schedules

Your system may be programmed for Area schedules that allows you to set a separate schedule for each area of the system. If so, after selecting the schedule type (**PRM**, **PRI**, **SEC**, or **TMP**) the keypad displays **AREA NO:** -. Enter the number of the area you want to enter schedules. Press **COMMAND** to continue.

You can also press either of the two left **SELECT** keys to browse through a list of the areas. Press **COMMAND** when the area name you want is displayed.

All/Perimeter or Home/Away systems: Your system may be programmed for Area schedules that allows you to set a separate schedule for just the perimeter or interior of the system. If so, after selecting the schedule type (**PRM**, **PRI**, **SEC**, or **TMP**) the keypad displays **INT PERIM**. Press the **SELECT** key under **INT** to program a schedule for just the interior of your system. Press the **SELECT** key under **PERIM** to program a schedule for just the perimeter.

Schedules continued

Area Schedules

Your system may be programmed for Area schedules that allows you to set a separate schedule for each area of the system. If so, after selecting the schedule type (**PRM**, **PRI**, **SEC**, or **TMP**) the keypad displays **AREA NO:** -. Enter the number of the area you want to enter schedules. Press **COMMAND** to continue.

You can also press either of the two left **SELECT** keys to browse through a list of the areas. Press **COMMAND** when the area name you want is displayed.

All/Perimeter or Home/Away systems: Your system may be programmed for Area schedules that allows you to set a separate schedule for just the perimeter or interior of the system. If so, after selecting the schedule type (**PRM**, **PRI**, **SEC**, or **TMP**) the keypad displays **INT PERIM**. Press the **SELECT** key under **INT** to program a schedule for just the interior of your system. Press the **SELECT** key under **PERIM** to program a schedule for just the perimeter.

Extending Schedules

User Code Level: 6 and above.

Depending on your system's programming, when the schedule expires (the **ON** time) you can extend the schedule to a later time. The keypad buzzer sounds and the keypad displays "area name" and **LATE** or **CLOSING TIME!**. This reminds users still on the premises to arm the system or extend the schedule.

To extend the system's schedule:

1. Press any **SELECT** key and the keypad will display **ENTER CODE:-**.
2. Enter your code and press **COMMAND**. The system's schedule is automatically extended one hour.
3. The keypad then displays -: **AM PM**. You can enter a time to extend the schedule for greater than one hour. Press **AM** or **PM**.

Note: If the system is not armed, or the schedule extended, a report is sent to the central station.

Extending Schedules

User Code Level: 6 and above.

Depending on your system's programming, when the schedule expires (the **ON** time) you can extend the schedule to a later time. The keypad buzzer sounds and the keypad displays "area name" and **LATE** or **CLOSING TIME!**. This reminds users still on the premises to arm the system or extend the schedule.

To extend the system's schedule:

1. Press any **SELECT** key and the keypad will display **ENTER CODE:-**.
2. Enter your code and press **COMMAND**. The system's schedule is automatically extended one hour.
3. The keypad then displays -: **AM PM**. You can enter a time to extend the schedule for greater than one hour. Press **AM** or **PM**.

Note: If the system is not armed, or the schedule extended, a report is sent to the central station.

Relay Output Schedules

The Schedules function allows you to set up to 50 different scheduled times for relays connected to your system to turn on and off automatically.

Programming Output Schedules:

1. Access the User Menu.
2. Press COMMAND until **SCHEDULES?** displays.
3. Press any SELECT key. The keypad displays **PRI TMP OUT** or (**PRI SEC OUT**). Press the SELECT key under **OUT**.
4. At the **OUTPUT NO:** – display, enter the relay output number you want to program. Press the COMMAND key.

If adding a schedule and all 50 are currently in use, you'll see an **OUT SCHEDS FULL** on the display. You must then delete or change an existing schedule.

5. The keypad displays **SUN MON TUE WED**. Press the COMMAND key to display **THU FRI SAT**.
6. Press the SELECT key under the day you want to program.

Note: After selecting the day of the week for the schedule to occur, the keypad displays any currently programmed On Off times previously set for that day. This feature allows you to review programmed schedules at any time.

7. If On Off times are displayed, the keypad then displays **DELETE KEEP**. Press the SELECT key under **DELETE** to enter new times.
8. The keypad then displays **ON TIME?**. This is followed by the display – : **AM PM**.
Enter a new relay On time and select **AM** or **PM**.
The display changes to **OFF TIME?**. This is followed by the display – : **AM PM**.
Enter a new Off time for the relay.
Enter all schedule times using a 12 hour clock. For example, to enter 6 AM you would enter a 0 + 6 + 0 + 0 and press the SELECT key under **AM**. For 11 PM you would enter a 1 + 1 + 0 + 0 and press the SELECT key under **PM**.
9. The keypad then goes back to the day of the week displays allowing you to enter another Output schedule. To exit the user menu or to go back to the **PRI TMP OUT** display, press the ARROW key.
10. To clear a schedule, press DELETE and then AM when the opening time is requested.

List your Opening and Closing schedules in the table provided on the following page for easy reference.

Relay Output Schedules

The Schedules function allows you to set up to 50 different scheduled times for relays connected to your system to turn on and off automatically.

Programming Output Schedules:

1. Access the User Menu.
2. Press COMMAND until **SCHEDULES?** displays.
3. Press any SELECT key. The keypad displays **PRI TMP OUT** or (**PRI SEC OUT**). Press the SELECT key under **OUT**.
4. At the **OUTPUT NO:** – display, enter the relay output number you want to program. Press the COMMAND key.

If adding a schedule and all 50 are currently in use, you'll see an **OUT SCHEDS FULL** on the display. You must then delete or change an existing schedule.

5. The keypad displays **SUN MON TUE WED**. Press the COMMAND key to display **THU FRI SAT**.
6. Press the SELECT key under the day you want to program.

Note: After selecting the day of the week for the schedule to occur, the keypad displays any currently programmed On Off times previously set for that day. This feature allows you to review programmed schedules at any time.

7. If On Off times are displayed, the keypad then displays **DELETE KEEP**. Press the SELECT key under **DELETE** to enter new times.
8. The keypad then displays **ON TIME?**. This is followed by the display – : **AM PM**.
Enter a new relay On time and select **AM** or **PM**.
The display changes to **OFF TIME?**. This is followed by the display – : **AM PM**.
Enter a new Off time for the relay.
Enter all schedule times using a 12 hour clock. For example, to enter 6 AM you would enter a 0 + 6 + 0 + 0 and press the SELECT key under **AM**. For 11 PM you would enter a 1 + 1 + 0 + 0 and press the SELECT key under **PM**.
9. The keypad then goes back to the day of the week displays allowing you to enter another Output schedule. To exit the user menu or to go back to the **PRI TMP OUT** display, press the ARROW key.
10. To clear a schedule, press DELETE and then AM when the opening time is requested.

List your Opening and Closing schedules in the table provided on the following page for easy reference.

Setting the Date and Time

User Code Level: 8 and above.

Function: Allows you to change the current date and time displayed on the Security Command keypad and used by the system to log events in its Event Memory program, and control schedules.

Setting the System's Date and Time

1. Access the User Menu.
2. Press COMMAND until **TIME?** displays.
3. The keypad displays the current day and time. Press the COMMAND key. The keypad displays the current date. Press the COMMAND key to make any changes.
4. The keypad displays **TIME DAY DATE**.
5. Press the SELECT key under **TIME** to change the time. The keypad displays – : **AM PM**. Enter the current time and select **AM** or **PM**.
The display changes back to **TIME DAY DATE**.
6. Press the SELECT key under **DAY** to change the day of week. The keypad displays **SUN MON TUE WED**. If the current day of the week is not displayed, press the COMMAND key.
7. The keypad displays **THU FRI SAT**. Press the SELECT key under the correct day. You can use the ARROW key to toggle between the two day of the week displays.

8. Press the SELECT key under **DATE** to change the date. The keypad displays

MONTH:- Enter one or two digits for the month.
Press COMMAND.

DAY:- Enter up to two digits for the day.
Press COMMAND.

YEAR:- Enter up to two digits for the year.
Press COMMAND.

The display returns to the **TIME DAY DATE** display. Press the ARROW key to exit the User Menu.

Note: The date and time portion of the Security Command System is year 2000 compliant.

User Menu **27**

Setting the Date and Time

User Code Level: 8 and above.

Function: Allows you to change the current date and time displayed on the Security Command keypad and used by the system to log events in its Event Memory program, and control schedules.

Setting the System's Date and Time

1. Access the User Menu.
2. Press COMMAND until **TIME?** displays.
3. The keypad displays the current day and time. Press the COMMAND key. The keypad displays the current date. Press the COMMAND key to make any changes.
4. The keypad displays **TIME DAY DATE**.
5. Press the SELECT key under **TIME** to change the time. The keypad displays – : **AM PM**. Enter the current time and select **AM** or **PM**.
The display changes back to **TIME DAY DATE**.
6. Press the SELECT key under **DAY** to change the day of week. The keypad displays **SUN MON TUE WED**. If the current day of the week is not displayed, press the COMMAND key.
7. The keypad displays **THU FRI SAT**. Press the SELECT key under the correct day. You can use the ARROW key to toggle between the two day of the week displays.

8. Press the SELECT key under **DATE** to change the date. The keypad displays

MONTH:- Enter one or two digits for the month.
Press COMMAND.

DAY:- Enter up to two digits for the day.
Press COMMAND.

YEAR:- Enter up to two digits for the year.
Press COMMAND.

The display returns to the **TIME DAY DATE** display. Press the ARROW key to exit the User Menu.

Note: The date and time portion of the Security Command System is year 2000 compliant.

User Menu **27**

Display Events

User Code Level: 1 and 2 - During schedules only. 3 to 9 - Anytime.

Function: Allows you to review up to 200 past system events.

There are six event types:

- Zone Activity** - Zone alarms, troubles, and restorals.
- Opening and Closing** - Arming and disarming of the system.
- User Code Changes** - Adding, deleting, and changing user codes.
- Schedule Changes** - Adding, deleting, and changing schedules.
- Door Access** - Each door access function used at a keypad.
- Supervisory** - Problems with the system's hardware components.

The system's memory can hold a maximum of 200 events for 45 days. Any event older than 45 days is cleared automatically by the system. Also, once the full 200 events are stored, any new event causes the oldest event to be cleared.

Using the Display Events

1. Access the User Menu.
2. Press the COMMAND key until **DISPLAY EVENTS?** displays. Press any SELECT key.
3. The keypad displays **FRST LST PRT SRT**. Select **FRST** (first) to view the oldest to newest events. Select **LST** (last) to view the newest to oldest events. If you select **FIRST**, use the COMMAND key to scroll up through the events. If you select **LAST**, use the ARROW key to scroll down through the events.

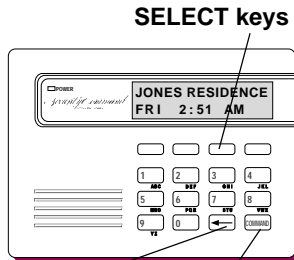

Select **PRT** (print) to print the complete Display Events log.

Select **SRT** (sort) to sort through the Display Events log and collect information specific to a user or system event.

4. To use the Sort feature, press the SELECT key under **SRT**. The keypad displays **FRST DATE: 8/21**. Press any SELECT key and enter a 4-digit beginning date for the sort. Press COMMAND.
5. The keypad displays **LAST DATE: 10/17**. Press any SELECT key and enter a 4-digit ending date for the sort. Press COMMAND.
6. The keypad displays **USER NUMBER: -**. To sort events for a particular user, enter their user number or press COMMAND to sort for all users. To search for a user, press any SELECT key then use the COMMAND and ARROW keys to browse through the user names in the system. When the user you want is displayed, press any SELECT key then press COMMAND.

7. The keypad next displays five event types that you can include in the sort. Press the *right* SELECT key to display **YES** as the event type name is displayed on the keypad. Press COMMAND.

The following are the five sort event types:

- ACCESSES** = door accesses granted.
- DOOR NUMBER** = leave blank for all doors.
- ZONE EVENTS** = zone alarms, troubles, and restorals.
- ARM/DISARM** = arming and disarming events.
- USER EVENTS** = adding, deleting, and changing user codes.
- SUPERVISORY** = system hardware problems.

8. After the last event type is displayed, the keypad again displays **FRST LST PRT SRT**. At this point, you can view or print the new sorted Display Events or press **SRT** for a new sort.

Display Events

User Code Level: 1 and 2 - During schedules only. 3 to 9 - Anytime.

Function: Allows you to review up to 200 past system events.

There are six event types:

- Zone Activity** - Zone alarms, troubles, and restorals.
- Opening and Closing** - Arming and disarming of the system.
- User Code Changes** - Adding, deleting, and changing user codes.
- Schedule Changes** - Adding, deleting, and changing schedules.
- Door Access** - Each door access function used at a keypad.
- Supervisory** - Problems with the system's hardware components.

The system's memory can hold a maximum of 200 events for 45 days. Any event older than 45 days is cleared automatically by the system. Also, once the full 200 events are stored, any new event causes the oldest event to be cleared.

Using the Display Events

1. Access the User Menu.
2. Press the COMMAND key until **DISPLAY EVENTS?** displays. Press any SELECT key.
3. The keypad displays **FRST LST PRT SRT**. Select **FRST** (first) to view the oldest to newest events. Select **LST** (last) to view the newest to oldest events. If you select **FIRST**, use the COMMAND key to scroll up through the events. If you select **LAST**, use the ARROW key to scroll down through the events.

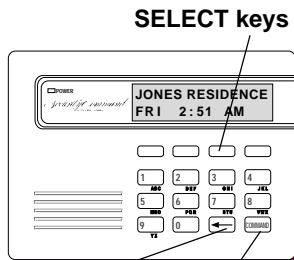

Select **PRT** (print) to print the complete Display Events log.

Select **SRT** (sort) to sort through the Display Events log and collect information specific to a user or system event.

4. To use the Sort feature, press the SELECT key under **SRT**. The keypad displays **FRST DATE: 8/21**. Press any SELECT key and enter a 4-digit beginning date for the sort. Press COMMAND.
5. The keypad displays **LAST DATE: 10/17**. Press any SELECT key and enter a 4-digit ending date for the sort. Press COMMAND.
6. The keypad displays **USER NUMBER: -**. To sort events for a particular user, enter their user number or press COMMAND to sort for all users. To search for a user, press any SELECT key then use the COMMAND and ARROW keys to browse through the user names in the system. When the user you want is displayed, press any SELECT key then press COMMAND.

7. The keypad next displays five event types that you can include in the sort. Press the *right* SELECT key to display **YES** as the event type name is displayed on the keypad. Press COMMAND.

The following are the five sort event types:

- ACCESSES** = door accesses granted.
- DOOR NUMBER** = leave blank for all doors.
- ZONE EVENTS** = zone alarms, troubles, and restorals.
- ARM/DISARM** = arming and disarming events.
- USER EVENTS** = adding, deleting, and changing user codes.
- SUPERVISORY** = system hardware problems.

8. After the last event type is displayed, the keypad again displays **FRST LST PRT SRT**. At this point, you can view or print the new sorted Display Events or press **SRT** for a new sort.

About the Display Events Section

This section of the user's guide shows the User's Guide Display Events items for both 16-character (single line) and 32-character keypad displays. While in the Display Events function, use the COMMAND and ARROW keys to go forward or backward through the list of events.

Arming and Disarming Event Displays

This displays any arming or disarming of system areas.

16-Character Display	Description
ARM 3 12 1017	Area 3 was armed by user 12 on Oct. 17. Press the SELECT key under 3 for the area name, under 12 for the user name, or under 1017 for the time the arming occurred.

32-Character Display	Description
ARM 5:10P 10/17 PERIMETER	The Perimeter was armed at 5:10 PM. Press any Select key to display the area number and user number then any Select key to display the user name.

Arming Event Types - There are 2 event type you may see here:

ARM - User armed the system **DIS** - User disarmed the system

About the Display Events Section

This section of the user's guide shows the User's Guide Display Events items for both 16-character (single line) and 32-character keypad displays. While in the Display Events function, use the COMMAND and ARROW keys to go forward or backward through the list of events.

Arming and Disarming Event Displays

This displays any arming or disarming of system areas.

16-Character Display	Description
ARM 3 12 1017	Area 3 was armed by user 12 on Oct. 17. Press the Select key under 3 for the area name, under 12 for the user name, or under 1017 for the time the arming occurred.

32-Character Display	Description
ARM 5:10P 10/17 PERIMETER	The Perimeter was armed at 5:10 PM. Press any Select key to display the area number and user number then any Select key to display the user name.

Arming Event Types - There are 2 event type you may see here:

ARM - User armed the system **DIS** - User disarmed the system

Zone Event Displays

This section displays alarms, troubles, and other events that could occur on your protection zones.

16-Character Display	Description
2 BURG ALR 1017	A burglary alarm occurred on zone 2. Press the <i>right</i> SELECT key for the time the alarm occurred.

32-Character Display	Description
ALR 10:23P 10/17 BASEMENT DOOR	An alarm occurred at 10:23 PM on Oct. 17. Press any SELECT key to see the zone number and zone type.

Zone Type - There are 7 possible zone types you may see here.

FIRE - Fire	PANC - Panic	BURG - Burglary
EMRG - Emergency	SUPV - Supervisory	
AUX1 - Auxiliary 1	AUX2 - Auxiliary 2	

Event Types - There are 6 event types you may see here:

ALR - Alarm	TBL - Trouble	RST - Restore
LOW - Low battery	MIS - Missing wireless transmitter	

Note: **LOW** and **MIS** are for wireless systems only.

Zone Event Displays

This section displays alarms, troubles, and other events that could occur on your protection zones.

16-Character Display	Description
2 BURG ALR 1017	A burglary alarm occurred on zone 2. Press the <i>right</i> Select key for the time the alarm occurred.

32-Character Display	Description
ALR 10:23P 10/17 BASEMENT DOOR	An alarm occurred at 10:23 PM on Oct. 17. Press any Select key to see the zone number and zone type.

Zone Type - There are 7 possible zone types you may see here.

FIRE - Fire	PANC - Panic	BURG - Burglary
EMRG - Emergency	SUPV - Supervisory	
AUX1 - Auxiliary 1	AUX2 - Auxiliary 2	

Event Types - There are 6 event type you may see here:

ALR - Alarm	TBL - Trouble	RST - Restore
LOW - Low battery	MIS - Missing wireless transmitter	

Note: **LOW** and **MIS** are for wireless systems only.

User Code Change Event Displays

This displays any addition, deletion, or change to a user code.

16-Character Display

Description

12 ADD 19 1017

User 12 added user 19 on Oct. 17. Press the *right* SELECT key for the time this occurred.

32-Character Display

Description

**ADD 11:41A 10/17
US:19 BY US:12**

User 19 added by user 12 at 11:41 AM. Press the Select key under either user (US:) number for the user name.

User Code Event Types - There are 3 event types you may see here:

ADD - User added **DEL** - User deleted

CHG - User code or authority level has been changed.

Supervisory Event Displays

This displays the date and time of an automatic test report.

16-Character Display

Description

AUTO RECALL 1017

The test report was sent on Oct. 17.

32-Character Display

Description

**MSG 11:58P 10/17
AUTO RECALL**

The test report was sent to the central station at the date and time shown.

User Code Change Event Displays

This displays any addition, deletion, or change to a user code.

16-Character Display

Description

12 ADD 19 1017

User 12 added user 19 on Oct. 17. Press the *right* Select key for the time this occurred.

32-Character Display

Description

**ADD 11:41A 10/17
US:19 BY US:12**

User 19 added by user 12 at 11:41 AM. Press the Select key under either user (US:) number for the user name.

User Code Event Types - There are 3 event type you may see here:

ADD - User added **DEL** - User deleted

CHG - User code or authority level has been changed.

Supervisory Event Displays

This displays the date and time of an automatic test report.

16-Character Display

Description

AUTO RECALL 1017

The test report was sent on Oct. 17.

32-Character Display

Description

**MSG 11:58P 10/17
AUTO RECALL**

The test report was sent to the central station at the date and time shown.

System Monitor Event Displays

This displays any problems with the system's AC power, battery, or phone line(s) or any opening of a tampered panel box.

16-Character Display

Description

POWER TBL 1017

An AC failure occurred on Oct. 17. Press the SELECT key under 1017 for the time.

32-Character Display

Description

**TBL 11:41A 10/17
POWER**

An AC failure occurred on Oct. 17. Press the SELECT key under 1017 for the time the failure occurred.

System Monitor Event Types - There are 2 event types:

TBL - Trouble

RST - Restore

System Monitor Event Names - There are 5 system monitors:

POWER - AC power to panel

BATTERY - On panel

LINE 1 - Phone line number 1

LINE 2 - Phone line number 2

TAMPER - On panel box

System Monitor Event Displays

This displays any problems with the system's AC power, battery, or phone line(s) or any opening of a tampered panel box.

16-Character Display

Description

POWER TBL 1017

An AC failure occurred on Oct. 17. Press the Select key under 1017 for the time.

32-Character Display

Description

**TBL 11:41A 10/17
POWER**

An AC failure occurred on Oct. 17. Press the Select key under 1017 for the time the failure occurred.

System Monitor Event Types - There are 2 event types:

TBL - Trouble

RST - Restore

System Monitor Event Names - There are 5 system monitors:

POWER - AC power to panel

BATTERY - On panel

LINE 1 - Phone line number 1

LINE 2 - Phone line number 2

TAMPER - On panel box

Door Access Event Displays

This displays the keypad address where a *Door Access occurred and the user number of the person granted access.

16-Character Display

DOOR 3 024 1017

Description

Door (keypad) #3 was accessed by user 24 on Oct. 17. Press the SELECT key under 1017 for the time of occurrence or under 024 for the user name.

32-Character Display

**ACC 5:18P 10/17
DOOR 3 USER:024**

Description

Door (keypad) #3 was accessed by user 24 on Oct. 17. Press the SELECT key under 1017 for the time of occurrence or under 024 for the user name.

About Door Access

Door Access is a feature available only on certain Security Command keypads that contain a built-in door releasing relay. When low voltage power for an electric door strike or magnetic lock is connected to the relay's contacts, users entering a valid user code can release the lock and gain access to the protected area.

The Display Events feature logs the user number and name of the person granted access, the date and time, and from which keypad they entered their code.

Door Access Event Displays

This displays the keypad address where a *Door Access occurred and the user number of the person granted access.

16-Character Display

DOOR 3 024 1017

Description

Door (keypad) #3 was accessed by user 24 on Oct. 17. Press the Select key under 1017 for the time of occurrence or under 024 for the user name.

32-Character Display

**ACC 5:18P 10/17
DOOR 3 USER:024**

Description

Door (keypad) #3 was accessed by user 24 on Oct. 17. Press the Select key under 1017 for the time of occurrence or under 024 for the user name.

About Door Access

Door Access is a feature available only on certain Security Command keypads that contain a built-in door releasing relay. When low voltage power for an electric door strike or magnetic lock is connected to the relay's contacts, only users entering a valid user code can release the lock and gain access to the protected area.

The Display Events feature logs the user number and name of the person granted access, the date and time, and from which keypad they entered their code.

Schedule Change Event Displays

This displays Changes made to the system's schedules.

16-Character Display

PRM MON 024 1017

Description

A Permanent schedule for Monday was changed by user 24 on Oct. 17. Press the SELECT key under 1017 for the time of occurrence or under 024 for the user name.

32-Character Display

**PRM 9:41A 10/17
SCH MON USER:024**

Description

A Permanent schedule for Monday was changed by user 24 on Oct. 17.

Schedule Types - There are 4 possible schedule types:

PRM - Permanent **TMP** - Temporary **PRI** - Primary
SEC - Secondary

MON - This is the day of the week in which the schedule change occurred. The days are displayed using three letters. Press the SELECT key under the day of the week to display the scheduled Opening time and once again for the scheduled Closing time.

024 - User number of the person who made the change. Press the SELECT key under this number to display the user's name.

Schedule Change Event Displays

This displays Changes made to the system's schedules.

16-Character Display

PRM MON 024 1017

Description

A Permanent schedule for Monday was changed by user 24 on Oct. 17. Press the Select key under 1017 for the time of occurrence or under 024 for the user name.

32-Character Display

**PRM 9:41A 10/17
SCH MON USER:024**

Description

A Permanent schedule for Monday was changed by user 24 on Oct. 17.

Schedule Types - There are 4 possible schedule types:

PRM - Permanent **TMP** - Temporary **PRI** - Primary
SEC - Secondary

MON - This is the day of the week in which the schedule change occurred. The days are displayed using three letters. Press the SELECT key under the day of the week to display the scheduled Opening time and once again for the scheduled Closing time.

024 - User number of the person who made the change. Press the SELECT key under this number to display the user's name.

Zone Bypass Event Displays

This displays the bypassing of system zones.

16-Character Display

26 BYPS 12 1017

Description

Zone 26 bypassed by user 12. Press the *left* SELECT key for the zone name and the *right* SELECT key for the time.

32-Character Display

**BYP 5:18P 10/17
EAST WINDOW**

Description

The east window zone was bypassed. Press a SELECT key for the zone number and user number. Press again for the user name.

Bypass Event Types - There are 4 event types:

BYP - Bypass **RST** - Restore **FRC** - Force Arm

FLT - Zone Fault

Note: You may sometimes see the user as **SWG**. This is short for Swinger Bypass, which is an automatic function that allows the system to bypass a zone.

SERVICE REQUEST?

This feature of the User Menu allows you to just press any top row SELECT key while **SERVICE REQUEST?** is displayed and have the system automatically send a "Request for Service" message to the central station. The display changes to **REQUEST MADE** momentarily to confirm your request was sent.

Our service department will then contact you to arrange a service appointment.

32 User Menu

Zone Bypass Event Displays

This displays the bypassing of system zones.

16-Character Display

26 BYPS 12 1017

Description

Zone 26 bypassed by user 12. Press the *left* Select key for the zone name and the *right* Select key for the time.

32-Character Display

**BYP 5:18P 10/17
EAST WINDOW**

Description

The east window zone was bypassed. Press a Select key for the zone number and user number. Press again for the user name.

Bypass Event Types - There are 4 event types:

BYP - Bypass **RST** - Restore **FRC** - Force Arm

FLT - Zone Fault

Note: You may sometimes see the user as **SWG**. This is short for Swinger Bypass which is an automatic function that allows the system to bypass a zone.

SERVICE REQUEST?

This feature of the User Menu allows you to just press any top row SELECT key while **SERVICE REQUEST?** is displayed and have the system automatically send a "Request for Service" message to the central station. The display changes to **REQUEST MADE** momentarily to confirm your request was sent.

Our service department will then contact you to arrange a service appointment.

32 User Menu

System Setup

We've provided this System Setup section to allow you to track the current and future status of the programmable options on your Security Command system. If you make changes to the system, you should update the information contained on these pages.

Your system is monitored by a central station.

Yes No

C/S Name: _____

Address: _____

City/State: _____

Emergency Phone: _____

Service Phone: _____

Service Manager: _____

Your system sends Opening and Closing reports.

Yes No

Your system sends Zone Bypass reports.

Yes No

Your system sends Ambush reports.

Yes No

System Setup

We've provided this System Setup section to allow you to track the current and future status of the programmable options on your Security Command system. If you make changes to the system, you should update the information contained on these pages.

Your system is monitored by a central station.

Yes No

C/S Name: _____

Address: _____

City/State: _____

Emergency Phone: _____

Service Phone: _____

Service Manager: _____

Your system sends Opening and Closing reports.

Yes No

Your system sends Zone Bypass reports.

Yes No

Your system sends Ambush reports.

Yes No

Security Command keypads

Address	Locations
1	_____
2	_____
3	_____
4	_____
5	_____
6	_____
7	_____
8	_____

Which keypads display System Status?

1 2 3 4 5 6 7 8 N/A

Which keypads display Armed Status?

1 2 3 4 5 6 7 8 N/A

Which keypads provide Door Access reports?

1 2 3 4 5 6 7 8 N/A

Security Command keypads

Address	Locations
1	_____
2	_____
3	_____
4	_____
5	_____
6	_____
7	_____
8	_____

Which keypads display System Status?

1 2 3 4 5 6 7 8 N/A

Which keypads display Armed Status?

1 2 3 4 5 6 7 8 N/A

Which keypads provide Door Access reports?

1 2 3 4 5 6 7 8 N/A

Area names and numbers

If you have an area system where your system is divided into up to eight separate areas, each area can have a custom name or description that displays at the keypad. This can help you easily track events when they occur elsewhere in your system.

Area	Name
1	_____
2	_____
3	_____
4	_____
5	_____
6	_____
7	_____
8	_____

Schedules

Your system uses the following schedule types:

- Permanent and Temporary schedules
- Primary and Secondary schedules

Output relays

Your system has _____ output relays that are used to control various functions within the building or around its perimeter. Below is a list of those relays and the devices they control.

Output #	What it controls
_____	_____
_____	_____
_____	_____
_____	_____
_____	_____
_____	_____
_____	_____
_____	_____
_____	_____
_____	_____

Use the Output number in the User Menu when setting Output Schedules or using the Outputs On Off option to manually toggle the relays.

Area names and numbers

If you have an area system where your system is divided into up to eight separate areas, each area can have a custom name or description that displays at the keypad. This can help you easily track events when they occur elsewhere in your system.

Area	Name
1	_____
2	_____
3	_____
4	_____
5	_____
6	_____
7	_____
8	_____

Schedules

Your system uses the following schedule types:

- Permanent and Temporary schedules
- Primary and Secondary schedules

Output relays

Your system has _____ output relays that are used to control various functions within the building or around its perimeter. Below is a list of those relays and the devices they control.

Output #	What it controls
_____	_____
_____	_____
_____	_____
_____	_____
_____	_____
_____	_____
_____	_____
_____	_____
_____	_____
_____	_____

Use the Output number in the User Menu when setting Output Schedules or using the Outputs On Off option to manually toggle the relays.

User Codes

Depending on how your system is programmed, you may have 50 to 200 user codes available. As you add new users or change current users' codes, you can keep track of their level of access to the system, and the areas in which their codes will operate.

Custom user codes

When adding codes to the system through the User Menu, you can choose the **CUSTOM** option to select the specific menu items you want the user to access.

After adding the code into the keypad you'll see the **LEVEL CUSTOM** display. Choosing **CUSTOM** displays the full list of keypad menu options one at a time. A **YES** next to the option means it is enabled for the user. To disable the option, press the second SELECT key from the right to display **NO**. See below:

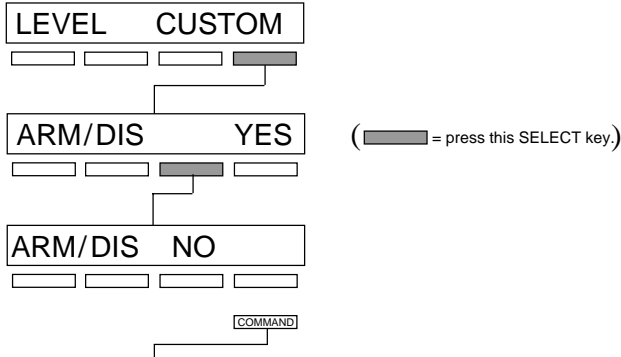

Press the COMMAND key to display the next menu option.

User Codes

Depending on how your system is programmed, you may have 50 to 200 user codes available. As you add new users or change current users' codes, you can keep track of their level of access to the system, and the areas in which their codes will operate.

Custom user codes

When adding codes to the system through the User Menu, you can choose the **CUSTOM** option to select the specific menu items you want the user to access.

After adding the code into the keypad you'll see the **LEVEL CUSTOM** display. Choosing **CUSTOM** displays the full list of keypad menu options one at a time. A **YES** next to the option means it is enabled for the user. To disable the option, press the second SELECT key from the right to display **NO**. See below:

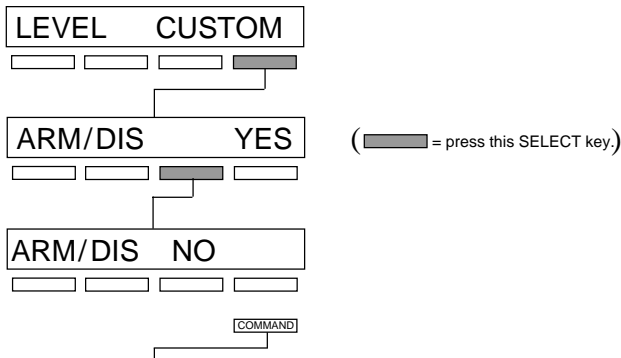

Press the COMMAND key to display the next menu option.

Use the following table to track custom user codes in your system.

User Name										
User #										
										Arm and Disarm
										Alarm Silence
										Sensor Reset
										Door Access
										Arm Areas
										Outputs on/off
										Zone Status
										Bypass Zones
										Zone Monitor
										System Status
										System Test
										User Codes
										Schedules
										Time
										Display Events
										Extend Closing
										Temporary Code
										Area 1
										Area 2
										Area 3
										Area 4
										Area 5
										Area 6
										Area 7
										Area 8

Suggestion: Photocopy this table before using.

Use the following table to track custom user codes in your system.

User Name										
User #										
										Arm and Disarm
										Alarm Silence
										Sensor Reset
										Door Access
										Arm Areas
										Outputs on/off
										Zone Status
										Bypass Zones
										Zone Monitor
										System Status
										System Test
										User Codes
										Schedules
										Time
										Display Events
										Extend Closing
										Temporary Code
										Area 1
										Area 2
										Area 3
										Area 4
										Area 5
										Area 6
										Area 7
										Area 8

Suggestion: Photocopy this table before using.

Frequently asked questions

This section of the user's guide attempts to answer questions you might have regarding the operation of your Security Command system.

Q. If I bypass an exit delay door when I arm the system, will I get an alarm if I come through it later?

A. You won't get an alarm from the door because it's bypassed but if you also walk through a motion detector or other armed door inside the premises you will get an alarm.

Q. When I arm or disarm my Area system, I get **ALL? NO YES** displayed. Does this mean all areas in the system?

A. Choosing **YES** arms or disarms all areas that are authorized for your user code.

Q. How do I create a schedule that starts at 8:00 am on Monday and ends at 5:00 PM on Friday.

A. In the days of the week display, select **MON** (Monday). For the **OPENING TIME?**, enter 0 + 8 + 0 + 0 AM. For the **CLOSING TIME?**, at the **MON — : AM PM** display press the SELECT key under **MON**; this scrolls through the days of the week. Stop at the day you want the schedule to end. Next, enter 0 + 5 + 0 + 0 PM into the **FRI — : AM PM** closing time display. Press COMMAND. Press the ARROW key to exit the User Menu.

This sets the opening time to 8:00 am Monday and the closing time to 5:00 PM Friday. You can substitute any other day or time in this example.

Frequently asked questions

This section of the user's guide attempts to answer questions you might have regarding the operation of your Security Command system.

Q. If I bypass an exit delay door when I arm the system, will I get an alarm if I come through it later?

A. You won't get an alarm from the door because it's bypassed but if you also walk through a motion detector or other armed door inside the premises you will get an alarm.

Q. When I arm or disarm my Area system, I get **ALL? NO YES** displayed. Does this mean all areas in the system?

A. Choosing **YES** arms or disarms all areas that are authorized for your user code.

Q. How do I create a schedule that starts at 8:00 am on Monday and ends at 5:00 PM on Friday.

A. In the days of the week display, select **MON** (Monday). For the **OPENING TIME?**, enter 0 + 8 + 0 + 0 AM. For the **CLOSING TIME?**, at the **MON — : AM PM** display press the SELECT key under **MON**; this scrolls through the days of the week. Stop at the day you want the schedule to end. Next, enter 0 + 5 + 0 + 0 PM into the **FRI — : AM PM** closing time display. Press COMMAND. Press the ARROW key to exit the User Menu.

This sets the opening time to 8:00 am Monday and the closing time to 5:00 PM Friday. You can substitute any other day or time in this example.

Q. What do I do if I want to be in the building past the scheduled closing (arming) time?

A. If your system is programmed for Closing Check, the keypad emits a steady tone after the schedule expires and displays "area name" **LATE** or **CLOSING TIME!**. During this display, pressing any SELECT key displays **ENTER CODE:** . Enter your user code and press COMMAND. Your schedule is automatically extended one hour.

The keypad now displays — : **AM PM**. Enter in the new time you want the schedule to expire and press COMMAND.

The time you enter may extend past midnight by pressing the **AM** key after the appropriate time has been entered.

Q. What do I do if I want to be in the building past the scheduled closing (arming) time?

A. If your system is programmed for Closing Check, the keypad emits a steady tone after the schedule expires and displays "area name" **LATE** or **CLOSING TIME!**. During this display, pressing any SELECT key displays **ENTER CODE:** . Enter your user code and press COMMAND. Your schedule is automatically extended one hour.

The keypad now displays — : **AM PM**. Enter in the new time you want the schedule to expire and press COMMAND.

The time you enter may extend past midnight by pressing the **AM** key after the appropriate time has been entered.

Zone Status Browser

Start Here

Access the User Menu. Press COMMAND until ZONE STATUS appears.

ZONE STATUS?

Press any SELECT key then press the SELECT key under NBR.

ARM BYPS ALR NBR

Press one of the left two SELECT keys to browse through the names of zones.

ZONE NO: -

SELECT AREA ...

This prompt allows you to search for a zone by area. Press the COMMAND key to scroll through the list of areas.

FRONT OFFICE

When the area where the zone is located is displayed, press any SELECT key.

24 HOUR ZONES

After all the areas are displayed, the system allows you to search through the 24 hour zones (Fire, Panic, Supervisory, etc.).

Press the COMMAND key to scroll through the list of all zone names.

SELECT ZONE ...

SELECT ZONE ...

When the correct zone name is displayed, press any SELECT key.

EAST DOOR

HALL SMOKE

When the correct zone name is displayed, press any SELECT key.

Verify the zone number matches the previously shown name.

ZONE NO : 0 1 2

ZONE NO : 0 3 4

Verify the zone number matches the previously shown name.

Press COMMAND.

Press COMMAND.

The system displays one of these zone status messages:
 -OKAY = the zone is normal
 -BYPAS = the zone is bypassed
 -BAD O = the zone is open
 -BAD S = the zone is shorted

EAST DOOR - OKAY

HALL SMOKE - OKAY

The system displays one of these zone status messages:
 -OKAY = the zone is normal
 -BYPAS = the zone is bypassed
 -BAD O = the zone is open
 -BAD S = the zone is shorted

Pressing COMMAND allows you to enter another zone number.

Zone Status Browser

Start Here

Access the User Menu. Press COMMAND until ZONE STATUS appears.

ZONE STATUS?

Press any SELECT key then press the SELECT key under NBR.

ARM BYPS ALR NBR

Press one of the left two SELECT keys to browse through the names of zones.

ZONE NO: -

SELECT AREA ...

This prompt allows you to search for a zone by area. Press the COMMAND key to scroll through the list of areas.

FRONT OFFICE

When the area where the zone is located is displayed, press any SELECT key.

24 HOUR ZONES

After all the areas are displayed, the system allows you to search through the 24 hour zones (Fire, Panic, Supervisory, etc.).

Press the COMMAND key to scroll through the list of all zone names.

SELECT ZONE ...

SELECT ZONE ...

When the correct zone name is displayed, press any SELECT key.

EAST DOOR

HALL SMOKE

When the correct zone name is displayed, press any SELECT key.

Verify the zone number matches the previously shown name.

ZONE NO : 0 1 2

ZONE NO : 0 3 4

Verify the zone number matches the previously shown name.

Press COMMAND.

Press COMMAND.

The system displays one of these zone status messages:
 -OKAY = the zone is normal
 -BYPAS = the zone is bypassed
 -BAD O = the zone is open
 -BAD S = the zone is shorted

EAST DOOR - OKAY

HALL SMOKE - OKAY

The system displays one of these zone status messages:
 -OKAY = the zone is normal
 -BYPAS = the zone is bypassed
 -BAD O = the zone is open
 -BAD S = the zone is shorted

Pressing COMMAND allows you to enter another zone number.

Bypass Zones Browser

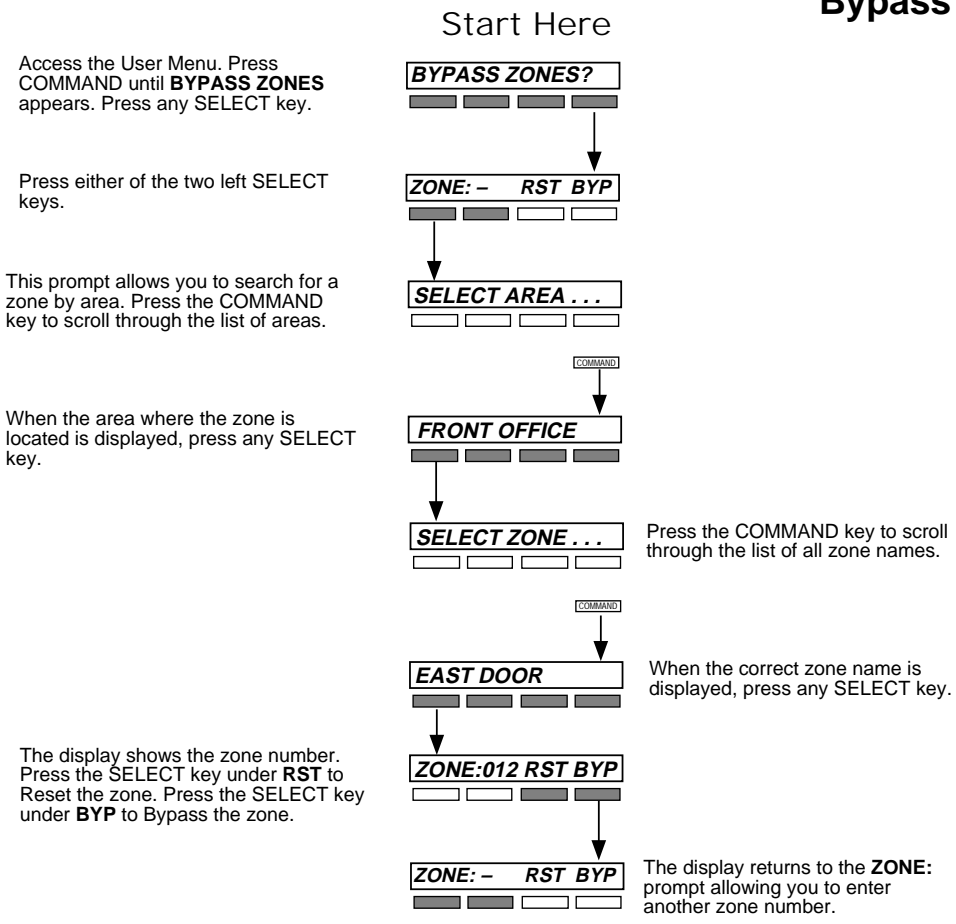

Bypass Zones Browser

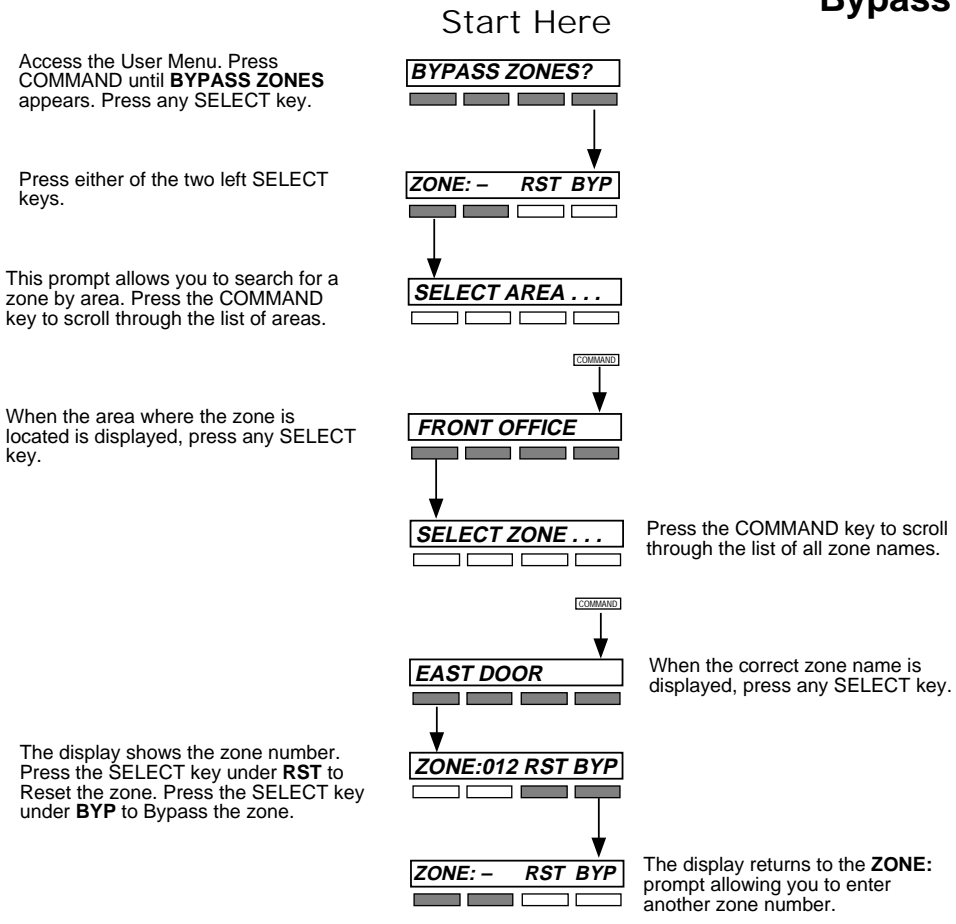

Zone Monitor Browser

Start Here



Access the User Menu. Press COMMAND until **ZONE MONITOR?** displays. Press any SELECT key.

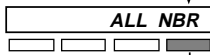

Press the SELECT key under **NBR**.

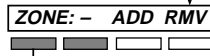

Press either of the two left SELECT keys.



This prompt allows you to search for a zone by area. Press the COMMAND key to scroll through the list of areas.

COMMAND



When the area where the zone is located is displayed, press any SELECT key.



Press the COMMAND key to scroll through the list of all zone names.

COMMAND



When the correct zone name is displayed, press any SELECT key.

The display shows the zone number.

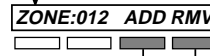

Selecting **ADD** puts the zone in the monitor mode.

Selecting **RMV** removes the zone from the monitor mode.

Zone Monitor Browser

Start Here



Access the User Menu. Press COMMAND until **ZONE MONITOR?** displays. Press any SELECT key.

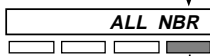

Press the SELECT key under **NBR**.

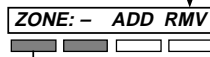

Press either of the two left SELECT keys.



This prompt allows you to search for a zone by area. Press the COMMAND key to scroll through the list of areas.

COMMAND



When the area where the zone is located is displayed, press any SELECT key.



Press the COMMAND key to scroll through the list of all zone names.

COMMAND



When the correct zone name is displayed, press any SELECT key.

The display shows the zone number.

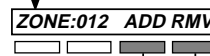

Selecting **ADD** puts the zone in the monitor mode.

Selecting **RMV** removes the zone from the monitor mode.

Add User Codes Browser

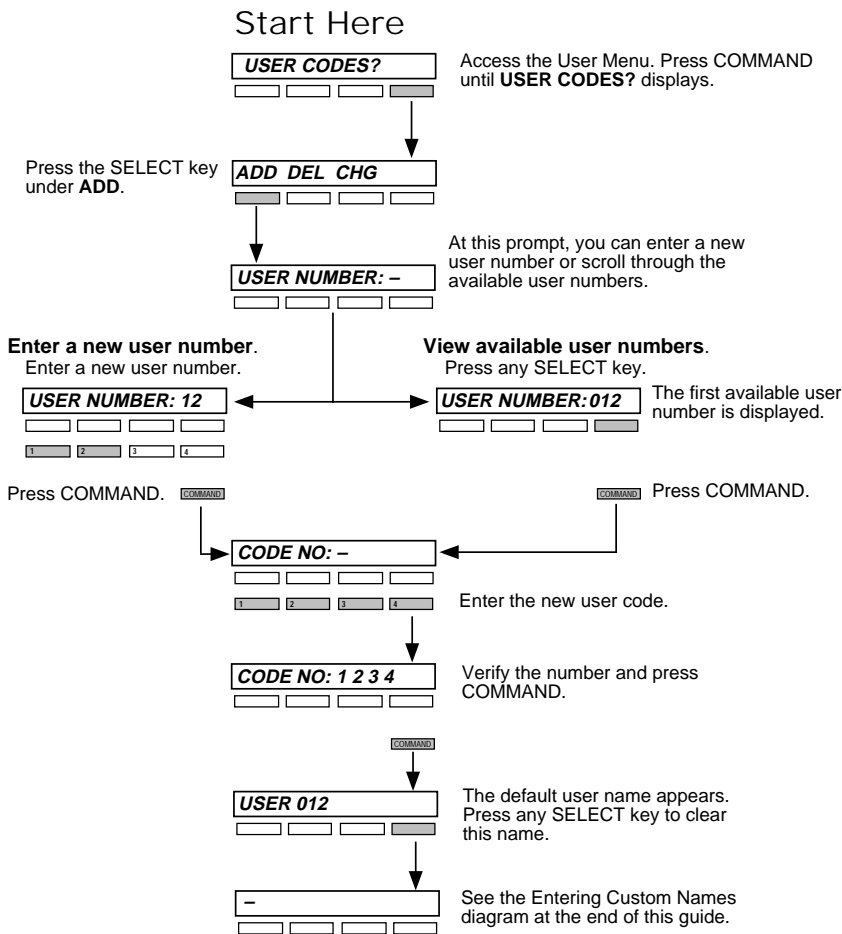

Add User Codes Browser

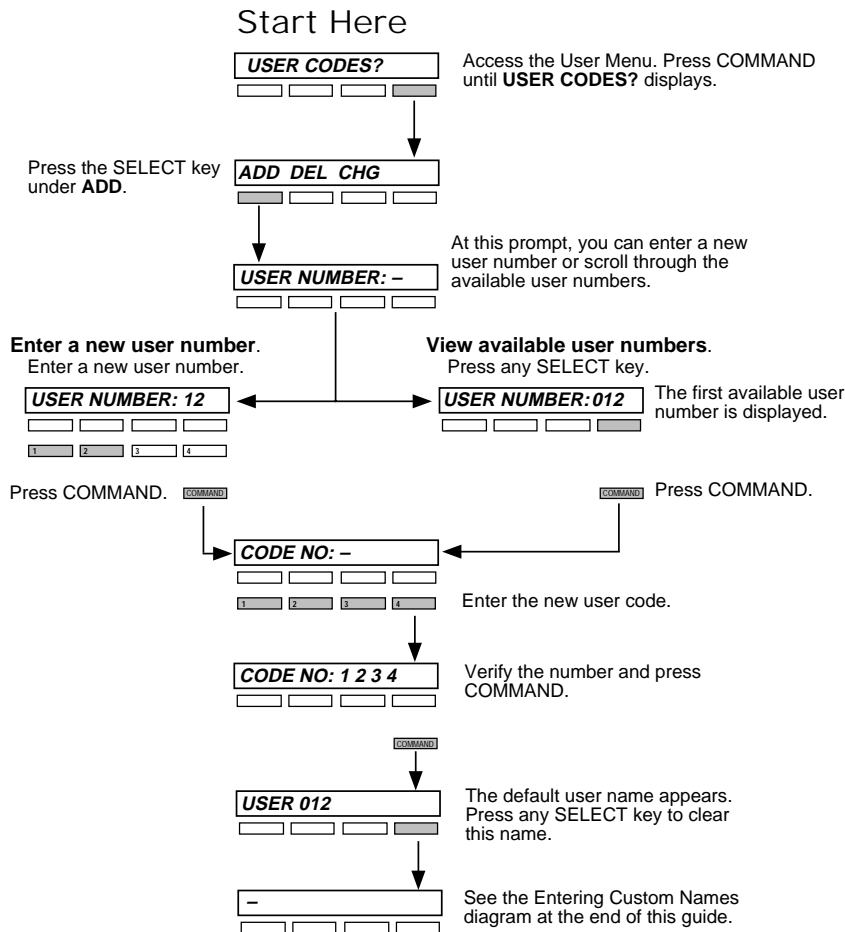

Delete User Codes Browser

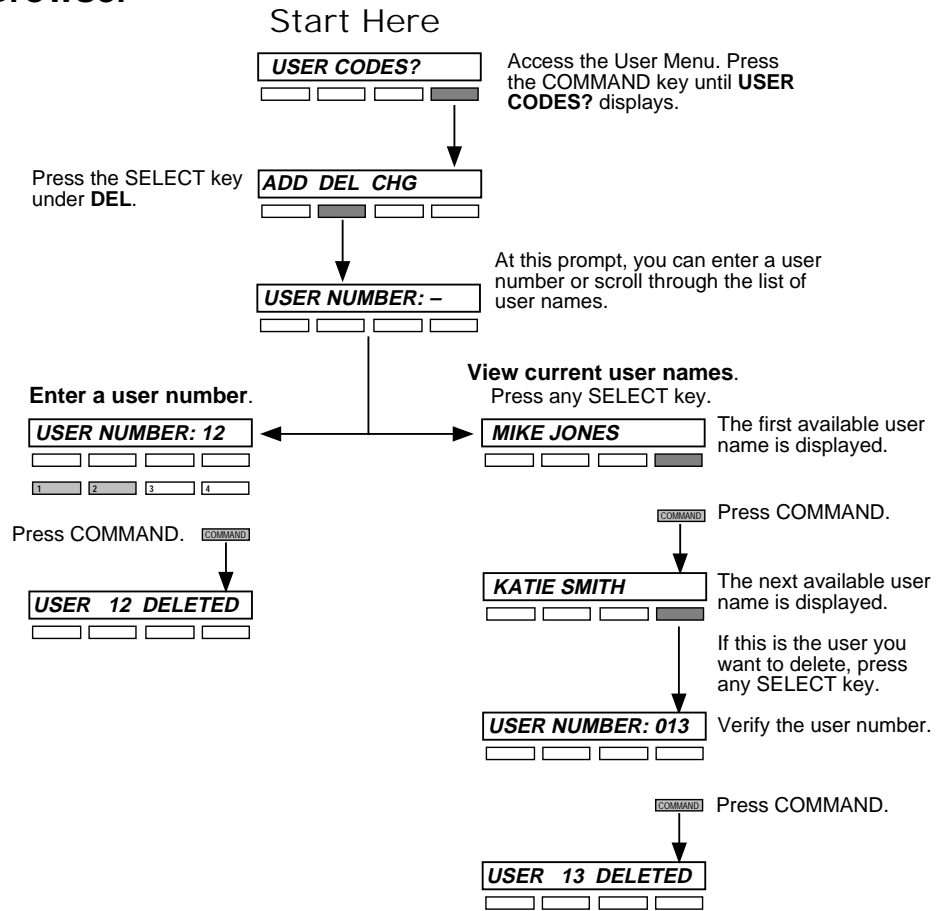

Delete User Codes Browser

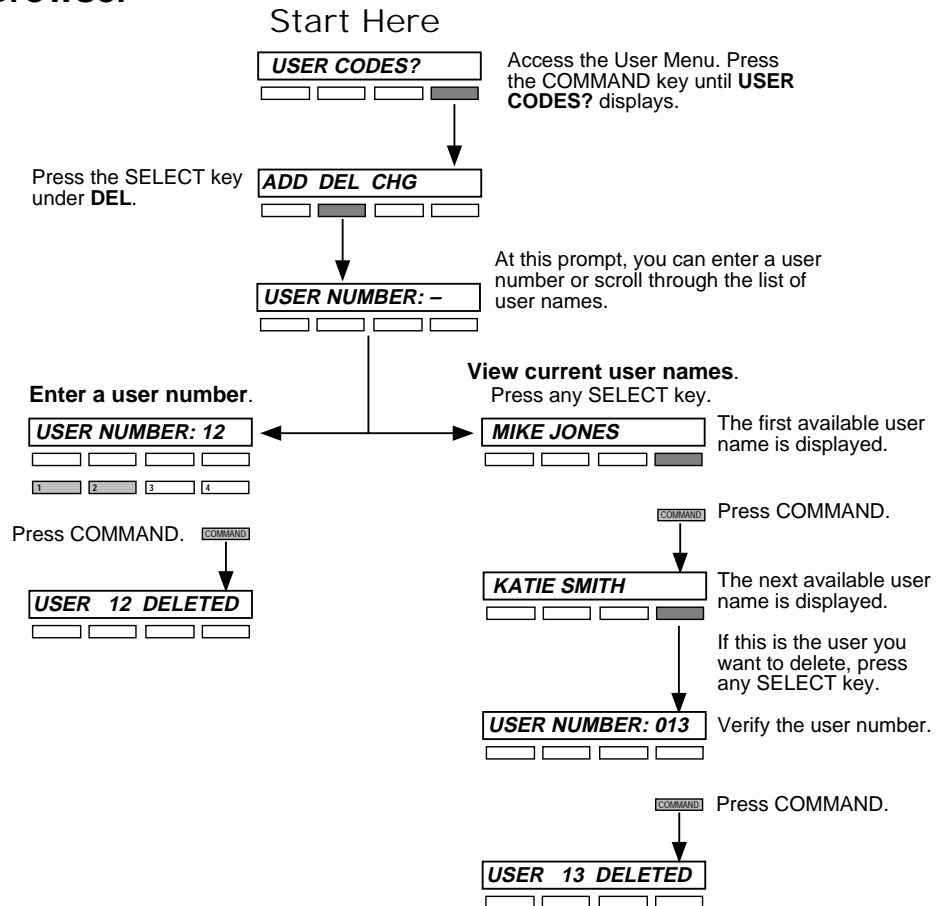

Change User Codes Browser

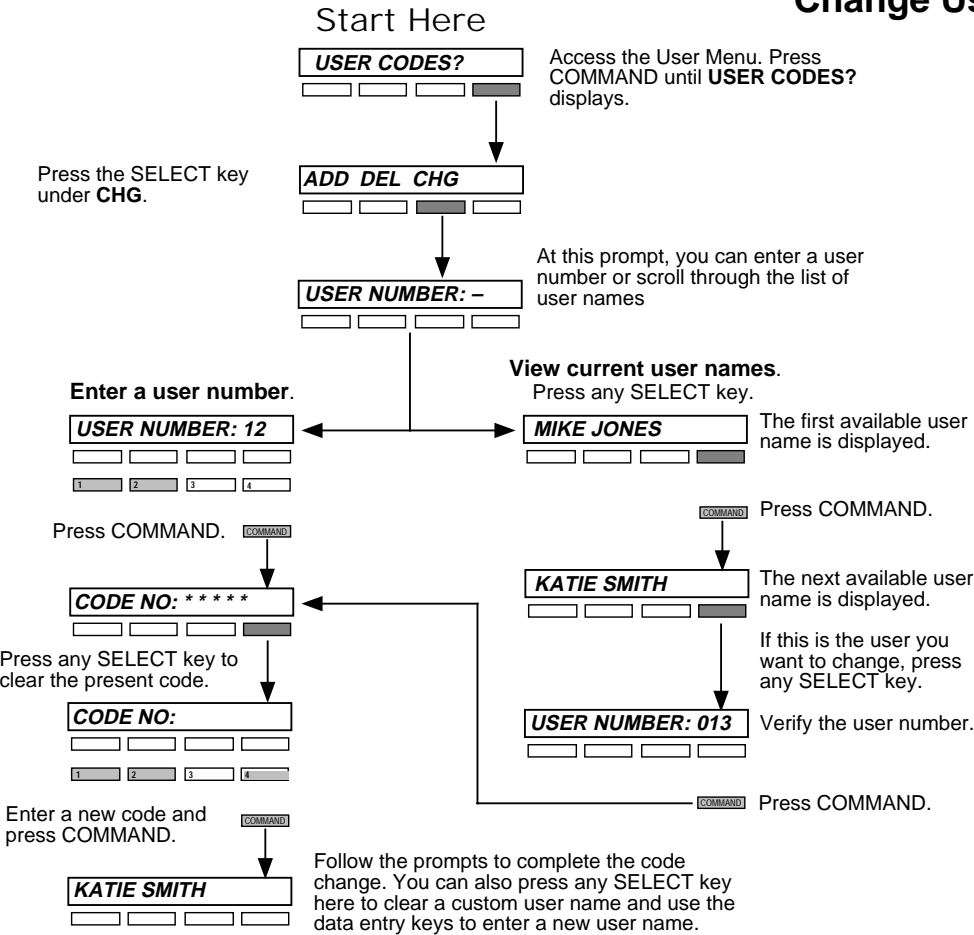

Change User Codes Browser

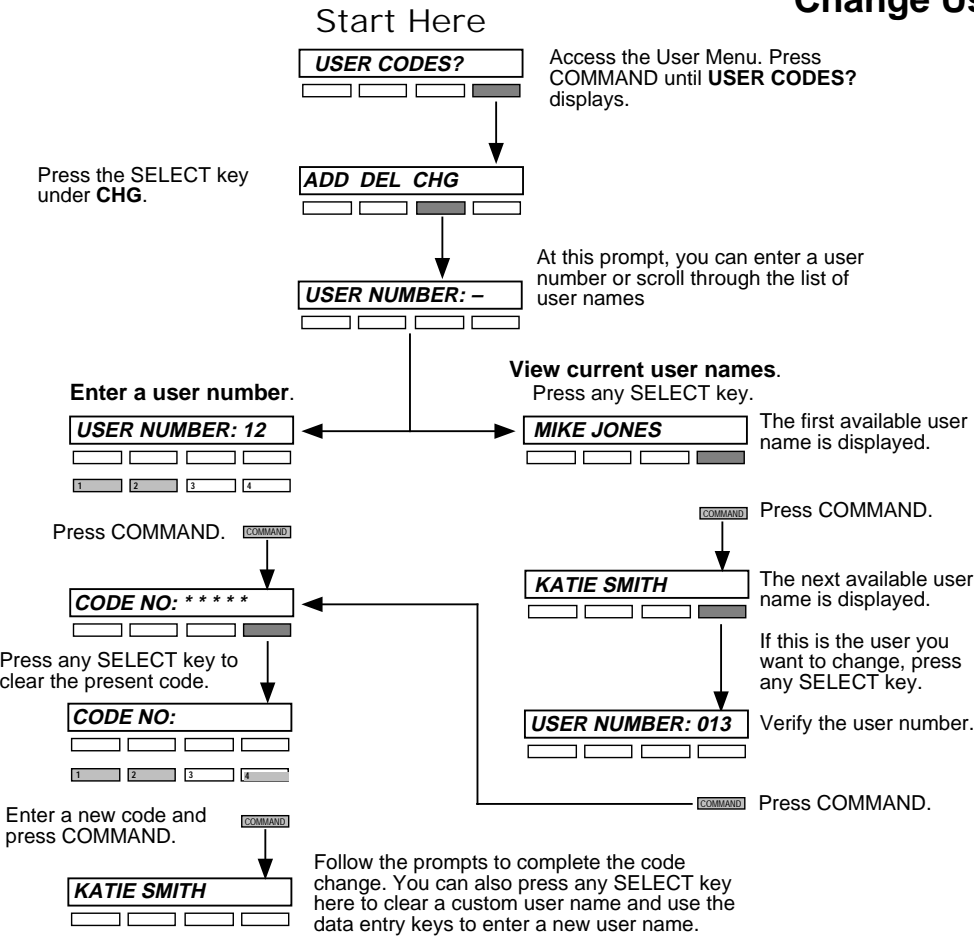

Entering Custom Names

1
To enter a custom name into the keypad, you'll be using the 3 rows of number keys.

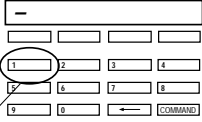

Once you've cleared the default name, the display shows just a dash on the left side.

2
Under each number key are three letters. To enter a custom name, press the number key above the letter you want to enter.

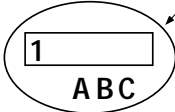

3
With the number displayed, press the SELECT key that matches the position of the letter. See example.

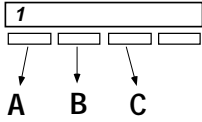

4
Once the letter you want is displayed, press the number key above the next letter you want to enter.

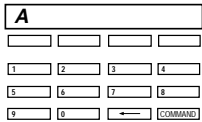

You can enter up to 16 characters for each name into the keypad.

The nine and zero keys . . .



Pressing the **9** key provides you with Y, Z, and a space that you can use between names. For example: BOB SMITH.

Pressing the **0** (zero) key provides you with a (dash), (period), (asterisk), and a (pound sign).

Entering Custom Names

1
To enter a custom name into the keypad, you'll be using the 3 rows of number keys.

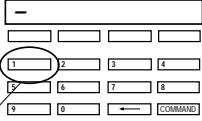

Once you've cleared the default name, the display shows just a dash on the left side.

2
Under each number key are three letters. To enter a custom name, press the number key above the letter you want to enter.

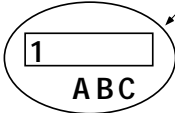

3
With the number displayed, press the SELECT key that matches the position of the letter. See example.

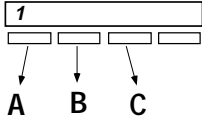

4
Once the letter you want is displayed, press the number key above the next letter you want to enter.

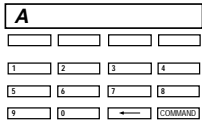

You can enter up to 16 characters for each name into the keypad.

The nine and zero keys . . .



Pressing the **9** key provides you with Y, Z, and a space that you can use between names. For example: BOB SMITH.

Pressing the **0** (zero) key provides you with a (dash), (period), (asterisk), and a (pound sign).

Easy Entry™ User's Guide

This section of the user's guide provides information on using the Easy Entry™ access control capability of the security command system. If your system is not currently using any access control devices, disregard this section. There are three different operating modes: Door Strike, Arming and Disarming, and Entry Delay. All of the examples below assume that your system requires a user code to arm and disarm the protection.

DOOR STRIKE

From the Status List, present your card to the reader. Once it is validated by the system, the Door Strike relay activates. Home/Away systems only activate the Door Strike relay when arming and disarming.

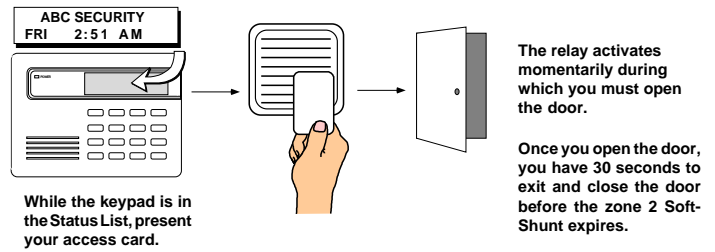

ARMING AND DISARMING AN AREA SYSTEM

Press Command. The keypad displays **ARM DISARM**. Press the Select key under either option. The keypad displays **ENTER CODE: -**. Present your card to the reader. Once it is validated by the system, all areas accessible by you arm or disarm automatically.

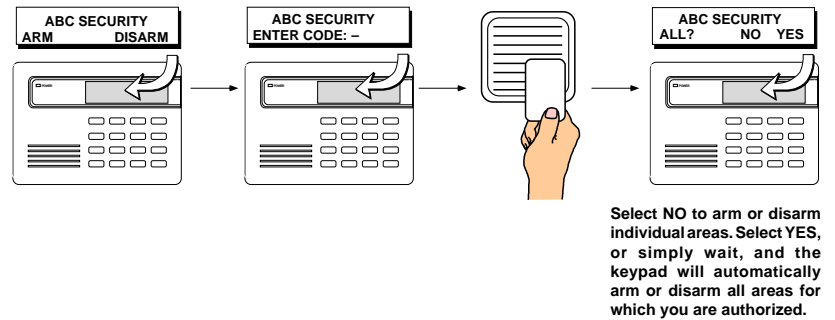

Easy Entry™ User's Guide

This section of the user's guide provides information on using the Easy Entry™ access control capability of the security command system. If your system is not currently using any access control devices, disregard this section. There are three different operating modes: Door Strike, Arming and Disarming, and Entry Delay. All of the examples below assume that your system requires a user code to arm and disarm the protection.

DOOR STRIKE

From the Status List, present your card to the reader. Once it is validated by the system, the Door Strike relay activates. Home/Away systems only activate the Door Strike relay when arming and disarming.

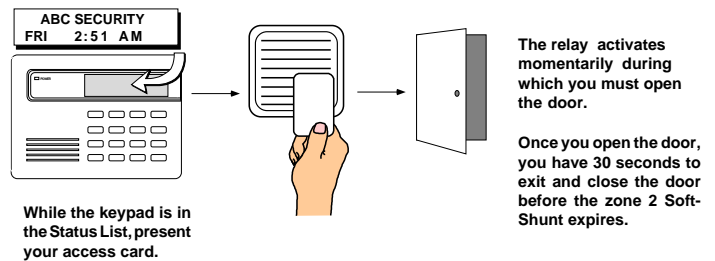

ARMING AND DISARMING AN AREA SYSTEM

Press Command. The keypad displays **ARM DISARM**. Press the Select key under either option. The keypad displays **ENTER CODE: -**. Present your card to the reader. Once it is validated by the system, all areas accessible by you arm or disarm automatically.

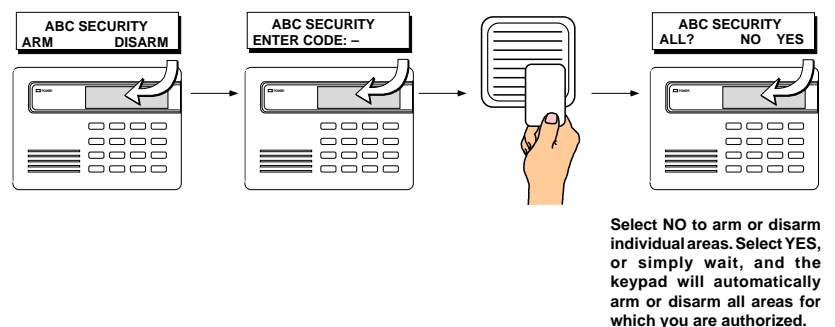

ARMING AND DISARMING AN ALL/PERIMETER SYSTEM

Press Command. The keypad displays **PERIM ALL** (when arming) or **DISARM?**. Press the Select key under the option. The keypad displays **ENTER CODE: -**.

Present your card to the reader. Once it is validated by the system, both areas arm or disarm automatically and the Door Strike relay activates.

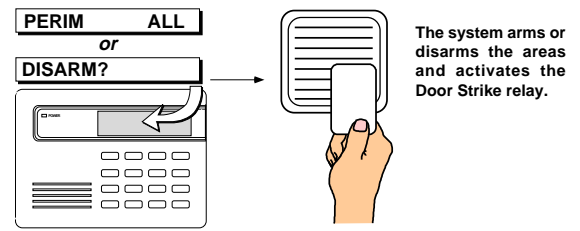

ARMING AND DISARMING A HOME/AWAY SYSTEM

Home/Away system Arming and Disarming - Present your card to the reader. If the system is armed, once the card is validated all areas are disarmed.

If the system is disarmed when you present your card, once it is validated all areas are armed in the **AWAY** mode.

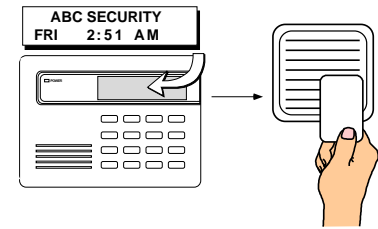

ENTRY DELAY

Once the protected door is opened and the entry delay starts, the keypad displays **ENTER CODE: -**. Present your card to the reader and, once it is validated, the system disarms all areas accessible by you. Area systems provide a delay to allow selected areas only to be disarmed. See Arming and Disarming above.

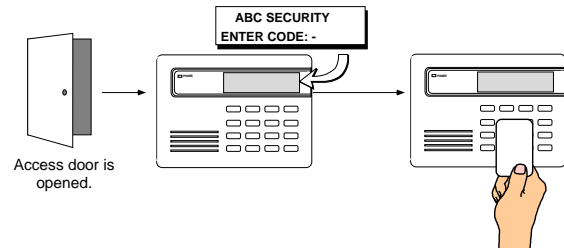

Using the access reader for user menu access

You can also use a card reader to access the User Menu when the **MENU? NO YES** display is shown, and a code is requested.

The system disarms the areas and activates the Door Strike relay. Area systems allow a delay for you to select only certain areas. See Arming and Disarming.

ARMING AND DISARMING AN ALL/PERIMETER SYSTEM

Press Command. The keypad displays **PERIM ALL** (when arming) or **DISARM?**. Press the Select key under the option. The keypad displays **ENTER CODE: -**.

Present your card to the reader. Once it is validated by the system, both areas arm or disarm automatically and the Door Strike relay activates.

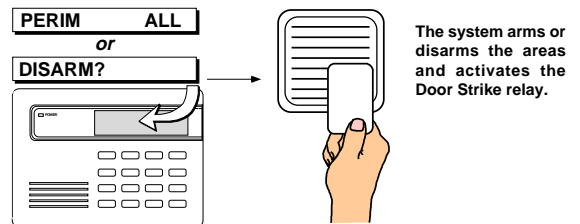

ARMING AND DISARMING A HOME/AWAY SYSTEM

Home/Away system Arming and Disarming - Present your card to the reader. If the system is armed, once the card is validated all areas are disarmed.

If the system is disarmed when you present your card, once it is validated all areas are armed in the **AWAY** mode.

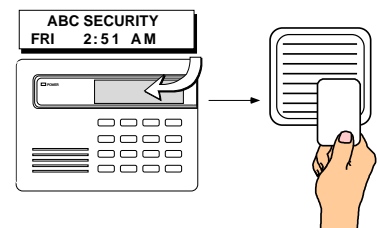

ENTRY DELAY

Once the protected door is opened and the entry delay starts, the keypad displays **ENTER CODE: -**. Present your card to the reader and, once it is validated, the system disarms all areas accessible by you. Area systems provide a delay to allow selected areas only to be disarmed. See Arming and Disarming above.

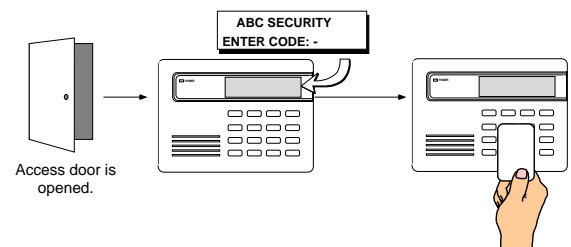

Using the access reader for user menu access

You can also use a card reader to access the User Menu when the **MENU? NO YES** display is shown, and a code is requested.

The system disarms the areas and activates the Door Strike relay. Area systems allow a delay for you to select only certain areas. See Arming and Disarming.

Pager Direct™ User's Guide

Pager Direct uses the reporting capability of your security system to dial your pager number and send reports in much the same way as someone sending you a pager message would do. You can receive reports of alarms, troubles, or armings and disarmings of the system and know at a glance the status of your system.

Area Names			
List your system's area names and numbers below:			
Area	Name	Area	Name
1 _____		3 _____	
2 _____		4 _____	
Service Department Phone: _____			
Emergency Phone: _____			
Central Station Phone: _____			
Pager Direct™			
			
Security Command Alphanumeric Paging			

Cut along dotted lines

Area Names			
List your system's area names and numbers below:			
Area	Name	Area	Name
1 _____		3 _____	
2 _____		4 _____	
Service Department Phone: _____			
Emergency Phone: _____			
Central Station Phone: _____			
Pager Direct™			
			
Security Command Numeric Paging			

Cut along dotted lines

Fold

Pager Direct™ User's Guide

Pager Direct uses the reporting capability of your security system to dial your pager number and send reports in much the same way as someone sending you a pager message would do. You can receive reports of alarms, troubles, or armings and disarmings of the system and know at a glance the status of your system.

Area Names			
List your system's area names and numbers below:			
Area	Name	Area	Name
1 _____		3 _____	
2 _____		4 _____	
Service Department Phone: _____			
Emergency Phone: _____			
Central Station Phone: _____			
Pager Direct™			
			
Security Command Alphanumeric Paging			

Cut along dotted lines

Area Names			
List your system's area names and numbers below:			
Area	Name	Area	Name
1 _____		3 _____	
2 _____		4 _____	
Service Department Phone: _____			
Emergency Phone: _____			
Central Station Phone: _____			
Pager Direct™			
			
Security Command Numeric Paging			

Cut along dotted lines

Fold

Numeric Pager Display

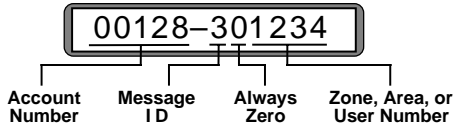

Account Number

This number has been programmed into your Security Command system as an identifier. Whenever the system sends a message to your pager, it will always send the account number first to identify itself.

Message ID

This is always a single digit, 1 to 6, that describes the message sent.

1 = Zone Alarm 3 = Area(s) Arming
2 = Zone Trouble 4 = Area(s) Disarming 6 = User Checkin

Zone, Area, or User Number

If this message is for a zone, the 1 to 3 digit zone number is displayed.
If this message is for areas that are being armed or disarmed, the area numbers are shown in sequential order. Example: 1 2 4.

Security Command Numeric Paging

Account Number

Whenever the system sends a message to your pager, it will always send the account number first to identify itself. After the account, you'll see:

Typical Zone Event Display Description

20002	001	NORTHWEST DOORS	BURG	*ALARM*	SHIPPING
Account	Zone	Zone Name	Zone Type	Event	Area Name

Zone Types - BURG, FIRE, SUPV (Supervisory), PANC (Panic), EMRG (Emergency), AUX1, or AUX2
Events - ALARM or TROUBLE

Typical Arming/Disarming Display Description

20002	ARMED	0016	WILLIAM SMITH	01	EAST WAREHOUSE
Account	Event	User #	User Name	Area #	Area Name

Events - ARMED or DISARMED

User Checkin Display Description

20002	USER CHECKIN REPORT	BY 0016	BILLY JONES
Account	Function Performed	User #	User Name

Functions - USER CHECKIN REPORT (An authorized user has selected Checkin from the User Menu)

Typical System Event Display Description

20002	LATE TO CLOSE
Account	Event

Events - LATE TO CLOSE (The system has not been armed at its scheduled closing time)
ALARM CANCELLED (An alarm has been cancelled by an authorized user)

Security Command Alphanumeric Paging

Numeric Pager Display

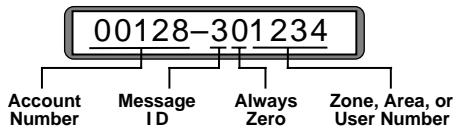

Account Number

This number has been programmed into your Security Command system as an identifier. Whenever the system sends a message to your pager, it will always send the account number first to identify itself.

Message ID

This is always a single digit, 1 to 6, that describes the message sent.

1 = Zone Alarm 3 = Area(s) Arming
2 = Zone Trouble 4 = Area(s) Disarming 6 = User Checkin

Zone, Area, or User Number

If this message is for a zone, the 1 to 3 digit zone number is displayed.
If this message is for areas that are being armed or disarmed, the area numbers are shown in sequential order. Example: 1 2 4.

Security Command Numeric Paging

Account Number

Whenever the system sends a message to your pager, it will always send the account number first to identify itself. After the account, you'll see:

Typical Zone Event Display Description

20002	001	NORTHWEST DOORS	BURG	*ALARM*	SHIPPING
Account	Zone	Zone Name	Zone Type	Event	Area Name

Zone Types - BURG, FIRE, SUPV (Supervisory), PANC (Panic), EMRG (Emergency), AUX1, or AUX2
Events - ALARM or TROUBLE

Typical Arming/Disarming Display Description

20002	ARMED	0016	WILLIAM SMITH	01	EAST WAREHOUSE
Account	Event	User #	User Name	Area #	Area Name

Events - ARMED or DISARMED

User Checkin Display Description

20002	USER CHECKIN REPORT	BY 0016	BILLY JONES
Account	Function Performed	User #	User Name

Functions - USER CHECKIN REPORT (An authorized user has selected Checkin from the User Menu)

Typical System Event Display Description

20002	LATE TO CLOSE
Account	Event

Events - LATE TO CLOSE (The system has not been armed at its scheduled closing time)
ALARM CANCELLED (An alarm has been cancelled by an authorized user)

Security Command Alphanumeric Paging

FA100 User's Guide

These instructions guide you through the operation of your system using the FA100 Wireless Command Transmitter. The FA100 operates for the Home/Away or ALL/Perimeter arming systems.

Arming a Home/Away or ALL/Perimeter System

1. Press the HOME button to arm the Perimeter burglary protection.
2. Press the AWAY button to arm all of the burglary protection.

Disarming a Home/Away or ALL/Perimeter System

1. Press the OFF button to disarm all of the burglary protection.

Using the ALERT Button

Pressing the ALERT button sends a Panic alarm to the panel. If your system is monitored by a central station, the proper authorities will be notified of the alarm.

FA113 User's Guide

These instructions guide you through the operation of your system using the FA113 Wireless Keychain Remote.

Arming

1. Press the ON button to arm all of the burglary protection.

Disarming

1. Press the OFF button to disarm all of the burglary protection.

Using the ALERT Buttons

Press the two ALERT buttons simultaneously to send a Panic alarm to the panel. If your system is monitored by a central station, the proper authorities will be notified of the alarm.

Appendix **49**

FA100 User's Guide

These instructions guide you through the operation of your system using the FA100 Wireless Command Transmitter. The FA100 operates for the Home/Away or ALL/Perimeter arming systems.

Arming a Home/Away or ALL/Perimeter System

1. Press the HOME button to arm the Perimeter burglary protection.
2. Press the AWAY button to arm all of the burglary protection.

Disarming a Home/Away or ALL/Perimeter System

1. Press the OFF button to disarm all of the burglary protection.

Using the ALERT Button

Pressing the ALERT button sends a Panic alarm to the panel. If your system is monitored by a central station, the proper authorities will be notified of the alarm.

FA113 User's Guide

These instructions guide you through the operation of your system using the FA113 Wireless Keychain Remote.

Arming

1. Press the ON button to arm all of the burglary protection.

Disarming

1. Press the OFF button to disarm all of the burglary protection.

Using the ALERT Buttons

Press the two ALERT buttons simultaneously to send a Panic alarm to the panel. If your system is monitored by a central station, the proper authorities will be notified of the alarm.

Appendix **49**

Index

- Alarm display 3
- Ambush codes 22
- Area Schedules 24
- Armed Message 6
- Arming
 - All/Perimeter mode 9, 46
 - Area mode 7, 45
 - Home/Away mode 11, 46
 - Instant mode 9, 11
 - using Easy Entry™ 45
 - with doors and windows open 6
- Bypassing a zone 17
 - restoring a bypassed zone 17
 - zones that can't be bypassed 17
- CLOSING TIME! display 23
- ONE MOMENT message 6
- Disarming 4
 - alarm display 8, 10, 12
 - clears alarm displays 5
 - during an alarm 10, 12
 - Easy Entry™ keypads 45
 - ENTER CODE display 3, 8, 10, 12
 - keypad display 8, 10, 12
 - only selected areas 8
 - prewarn tone 8, 10, 12
 - reporting to central station 8, 10, 12
- Door Strike operation 45
- Easy Entry™ 45
- Emergency procedures ii
- Entry and Exit zones 5
- Events held in memory
 - amount 28
- False Alarms 1
- Keypad Messages 3
 - ALARM CANCELLED 10, 12
 - BAD * 6
 - CLOSING TIME! 23
 - ONE MOMENT ... 6
 - INSTNT 9, 11
 - LOCAL ALARM ONLY 6
- Keypad operation 2
- Keypad tones
 - during a trouble condition 4
 - entering while armed 4
 - Zone Monitor tone 4
- Keyswitch operation
 - exit delay display 6
- Monitoring zones 18
- Outputs
 - names and numbers 16, 34
 - turning on and off 16
- Pager reporting 47
 - quick reference card 47
- Perimeter protection 4
 - arming 9, 11
- Power (AC) LED 2
- Priority zone
 - BAD * condition 6
- Relay (output) control 16
- Resetting a smoke detector 14
- Security Command keypad 1, 2
- Sending reports to a Central station 5, 8, 10, 12
- Sending reports to your pager 47
- Sensor Reset 14
 - before using 14
 - for wireless systems 14
- Silent alarm 21
- System Setup 33
- System status 5
- Testing the system 1
- Turning the system off 8, 10, 12
- Turning the system on 7, 9, 11
- User Codes 20
 - Ambush codes 21
 - areas 20
 - authority level 21, 22
 - deleting 22
- Temporary codes 21
 - user number 20
 - user names 20
- User Menu 1
 - accessing 13, 46
 - restrictions 20
- Using Schedules 23
 - automatic arming 23
 - automatic disarming 23
- Using the keypad 2
 - arrow key 2
 - command key 2
 - top row keys 2
- Viewing past events 28
 - arming and disarming 29
 - system troubles 30
 - user code changes 30
 - zone alarms and troubles 29
- Wireless
 - FA100 49
 - FA113 49
 - Keychain Remote 49
 - low battery displays 3
- Zones 5
 - 24 hour zones 5
 - bypassed 6
 - force armed 6
 - Zone Monitor 18

50 Appendix

Index

- Alarm display 3
- Ambush codes 22
- Area Schedules 24
- Armed Message 6
- Arming
 - All/Perimeter mode 9, 46
 - Area mode 7, 45
 - Home/Away mode 11, 46
 - Instant mode 9, 11
 - using Easy Entry™ 45
 - with doors and windows open 6
- Bypassing a zone 17
 - restoring a bypassed zone 17
 - zones that can't be bypassed 17
- CLOSING TIME! display 23
- ONE MOMENT message 6
- Disarming 4
 - alarm display 8, 10, 12
 - clears alarm displays 5
 - during an alarm 10, 12
 - Easy Entry™ keypads 45
 - ENTER CODE display 3, 8, 10, 12
 - keypad display 8, 10, 12
 - only selected areas 8
 - prewarn tone 8, 10, 12
 - reporting to central station 8, 10, 12
- Door Strike operation 45
- Easy Entry™ 45
- Emergency procedures ii
- Entry and Exit zones 5
- Events held in memory
 - amount 28
- False Alarms 1
- Keypad Messages 3
 - ALARM CANCELLED 10, 12
 - BAD * 6
 - CLOSING TIME! 23
 - ONE MOMENT ... 6
 - INSTNT 9, 11
 - LOCAL ALARM ONLY 6
- Keypad operation 2
- Keypad tones
 - during a trouble condition 4
 - entering while armed 4
 - Zone Monitor tone 4
- Keyswitch operation
 - exit delay display 6
- Monitoring zones 18
- Outputs
 - names and numbers 16, 34
 - turning on and off 16
- Pager reporting 47
 - quick reference card 47
- Perimeter protection 4
 - arming 9, 11
- Power (AC) LED 2
- Priority zone
 - BAD * condition 6
- Relay (output) control 16
- Resetting a smoke detector 14
- Security Command keypad 1, 2
- Sending reports to a Central station 5, 8, 10, 12
- Sending reports to your pager 47
- Sensor Reset 14
 - before using 14
 - for wireless systems 14
- Silent alarm 21
- System Setup 33
- System status 5
- Testing the system 1
- Turning the system off 8, 10, 12
- Turning the system on 7, 9, 11
- User Codes 20
 - Ambush codes 21
 - areas 20
 - authority level 21, 22
 - deleting 22
- Temporary codes 21
 - user number 20
 - user names 20
- User Menu 1
 - accessing 13, 46
 - restrictions 20
- Using Schedules 23
 - automatic arming 23
 - automatic disarming 23
- Using the keypad 2
 - arrow key 2
 - command key 2
 - top row keys 2
- Viewing past events 28
 - arming and disarming 29
 - system troubles 30
 - user code changes 30
 - zone alarms and troubles 29
- Wireless
 - FA100 49
 - FA113 49
 - Keychain Remote 49
 - low battery displays 3
- Zones 5
 - 24 hour zones 5
 - bypassed 6
 - force armed 6
 - Zone Monitor 18

50 Appendix

